



# **MMB Roundline Cylinders**

*ISO 6020/1 cylinders for  
working pressures up to 160 bar*

*Catalogue HY07-1215/UK  
February 2006*



## **ГИДРОМОТОРС**

**(812) 400-69-69**

**[www.gidro-motors.ru](http://www.gidro-motors.ru)**

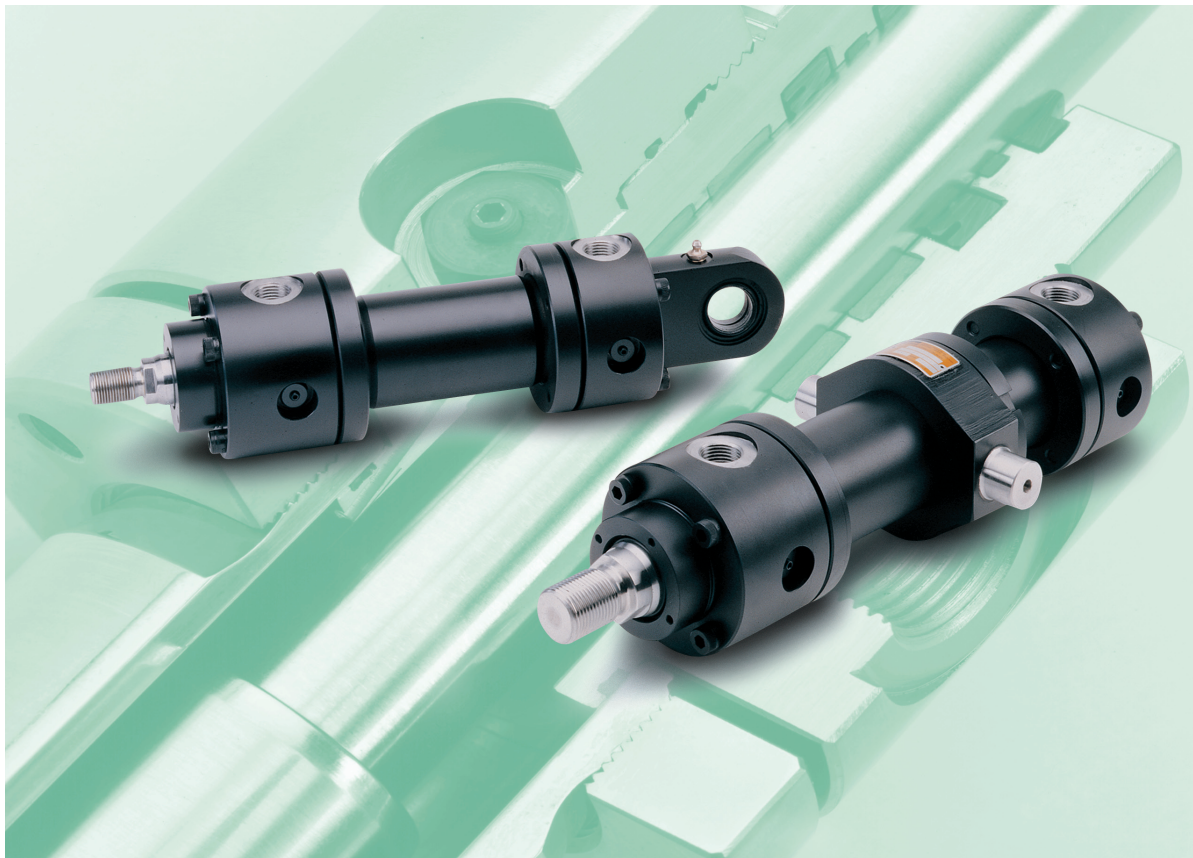

**Contents**

Introduction	2
Design Features and Benefits	3
Rectangular Flange Mountings	4
Round Flange Mountings	5
Pivot Mountings	6
Foot and Trunnion Mountings	7
Piston Rod End Data	8
Accessories	9
Calculation of Cylinder Diameter	10
Mounting Information	10
Gland and Piston Seal Options	10
Piston Rod Size Selection	11
Long Stroke Cylinders	11
Stop Tubes	12
Stroke Factors	12
Cushioning	13
Seals and Fluids	15
Cylinder Masses	15
Ports	16
Replacement Parts and Service	17
How to Order Cylinders	19

**Introduction**

The Series MMB roundline or 'mill' cylinder delivers continuous high performance with low whole-life costs in arduous applications such as steel mills, where a rugged, durable cylinder with a 'clean' external design is required. In addition to the standard cylinders featured in this catalogue, MMB cylinders can be designed and manufactured to suit individual customer requirements. Our engineers will be pleased to discuss and advise on unique designs to suit specific applications.

Parker Hannifin Corporation is a world leader in the manufacture of systems and components for motion control. Parker has more than 800 product lines for hydraulic, pneumatic and electromechanical applications in some 1200 industrial and aerospace markets. With more than 50,000 employees and over 200 manufacturing plants and administrative offices around the world, Parker provides customers with technical excellence and first class customer service.

Parker Hannifin's Cylinder Division is the world's largest supplier of hydraulic cylinders for industrial applications. Parker cylinders are used in applications as diverse as machine tools, flight simulation and tidal barrier control.

Visit us at [www.parker.com/uk](http://www.parker.com/uk)

**Standard Specifications**

- Heavy Duty construction
- Styles and dimensions to: CETOP RP58H, ISO 6020/1
- Rated pressure: 160 bar
- Fatigue-free at the rated pressure
- Hydraulic mineral oil – others on request
- Temperature range of standard seals: -20°C to +80°C
- Construction: head and cap bolted to heavy steel flanges
- Bore sizes: 40mm to 320mm
- Piston rod diameters: 22mm to 220mm

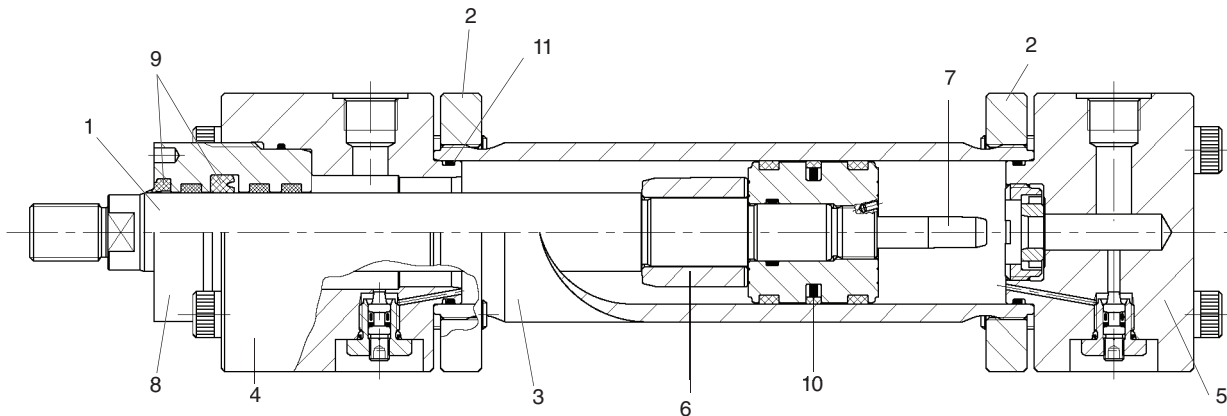

Note: In line with our policy of continuing product improvement, specifications in this catalogue are subject to change without notice.

## 1 Piston Rod

Manufactured from precision ground, high tensile carbon steel for long working life, piston rods are hard chrome plated and polished to 0.2µm max. All rod and piston assemblies have a minimum of 4:1 safety factor at the smallest cross sectional area, based on tensile strength at rated pressures.

## 2 Head and Cap Retention

The head and cap are bolted to heavy steel flanges, which are retained by threads at each end of the cylinder body.

## 3 Cylinder Body

The heavy wall steel tubing is honed to a high surface finish, to minimise internal friction and prolong seal life.

## 4 & 5 Head & Cap Ends

The head and cap are machined from steel and located into the cylinder body's internal diameter for added strength and precise alignment. To ensure leak-free performance, both are sealed by 'O' rings which are, in turn, protected by anti-extrusion rings.

## 6 & 7 Cushioning

Optional cushions are progressive in action, providing controlled deceleration which reduces noise and shock loading, and prolongs machine life. The head end cushion is a self-centring sleeve, while the polished cap end spear is an integral part of the rod. Needle valves are provided for precise cushion adjustment. Integral check valves minimise restriction to cylinder motion at the start of a stroke, allowing the rapid development of full piston speed for high cycling performance. For greater operator safety, the cushion needle valves are retained to prevent inadvertent removal.

## 8 Rod Gland and Bearings

The detachable steel rod gland features heavy duty polymer bearing rings to resist side loadings. Wide separation of these rings reduces bearing stresses, maximising the service life of the bearing.

The polymer bearing rings, with the rod seals, are easily replaced on removal of the rod gland, and all components may be serviced without further disassembly of the cylinder.

## 9 Gland Seals

The gland seals are located in a detachable gland housing for quick, easy maintenance, and provide efficient retention of pressurized fluid while preventing the ingress of contaminants.

## 10 Piston Seals

Standard and chevron-type piston seal options are available, to suit different applications – see page 10. In addition, MMB cylinders can be designed and manufactured to suit individual customer requirements. Please contact the factory for details.

## 11 Body End Seals

To ensure leak free performance, body end seals and gland/head seals are of radial construction, avoiding the problems of 'nibbling' and early failure associated with face-type seals.

## Optional Features

- Low friction seals
- High temperature seals
- Special materials
- Special paint finishes
- Alternative rod threads
- Maintenance free spherical bearings
- Air bleeds
- Gland drains
- Ports
- Position feedback
- Position switches
- Double rodded cylinders
- Rod bellows
- Metallic rod wipers
- Marine specification materials and finishes

## Special Designs

Parker's design and engineering staff are available to produce special designs to incorporate customer's specific requirements. Alternative sealing arrangements, special mounting styles, higher or lower rated pressure designs, welded cap ends to reduce overall length (non-cushioned only), larger cylinder bores and alternative rod sizes are just a few of the special requirements which can be accommodated.

## Servicing Features

All cylinders will, at some time, need maintenance or repairs. For maximum productivity with minimum downtime, the MMB series incorporates the following design features:

**Removable Gland** – Rod bearing and rod seals can be replaced without completely dismantling the cylinder.

**Chamfers** at both ends of the cylinder body ease assembly of the head and cap and insertion of the piston seals.

**Retaining flanges** are removable, allowing separate replacement of the cylinder body.

**High tensile bolts** are used for ease of maintenance and replacement.

**Flanges** are spaced from the head and cap to allow the bolts to be sawn through in the event of severe damage or corrosion.

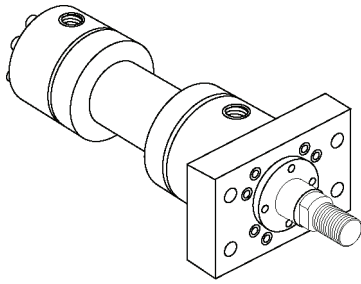

**Style MF1**  
Head Rectangular Flange

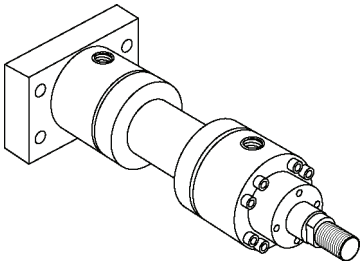
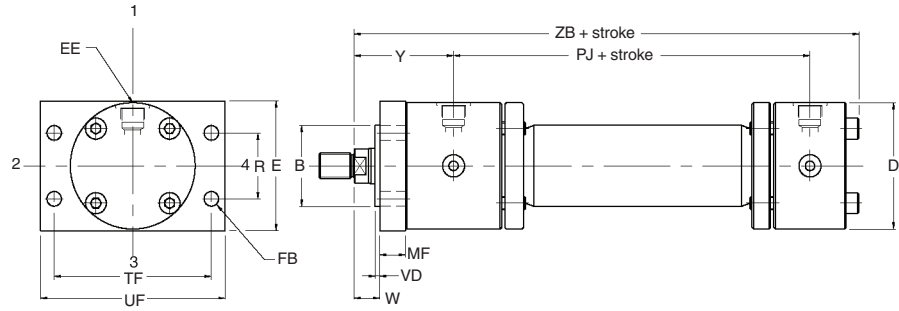

**Style MF2**  
Cap Rectangular Flange

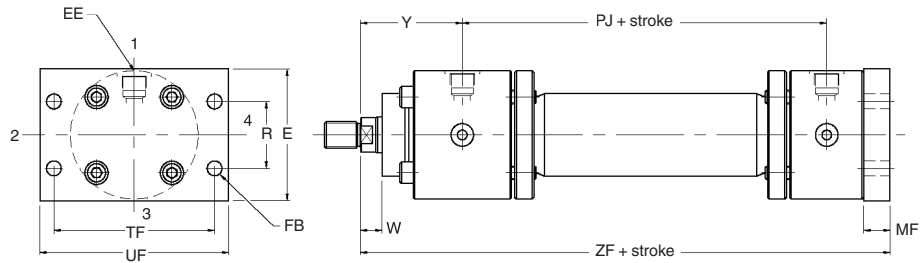

**Dimensions – MF1 and MF2** See also Rod End Dimensions, page 8

Bore Ø	Rod No.	MM Rod Ø	B f8	D max	E	EE (BSPP)	FB h13	MF	R	TF	UF	VD	W	Y	+ stroke		
															PJ	ZB max	ZF
40	1 2	22 28	50	78	80	G <sup>1</sup> / <sub>2</sub>	9	16	40.6	98	115	3	16	71	97	198	206
50	1 2	28 36	60	95	100	G <sup>1</sup> / <sub>2</sub>	11	20	48.2	116.4	140	4	18	72	111	213	225
63	1 2	36 45	70	116	120	G <sup>3</sup> / <sub>4</sub>	13.5	25	55.5	134	160	4	20	82	117	236	249
80	1 2	45 56	85	130	135	G <sup>3</sup> / <sub>4</sub>	17.5	32	63.1	152.5	185	4	22	91	134	262	282
100	1 2	56 70	106	158	160	G1	22	32	76.5	184.8	225	5	25	108	162	314	332
125	1 2	70 90	132	192	195	G1	22	32	90.2	217.1	255	5	28	121	174	341	357
160	1 2	90 110	-	-	-	-	-	-	-	-	-	-	-	-	-	-	-
200	1 2	110 140	-	-	-	-	-	-	-	-	-	-	-	-	-	-	-
250	1 2	140 180	-	-	-	-	-	-	-	-	-	-	-	-	-	-	-
320	1 2	180 220	-	-	-	-	-	-	-	-	-	-	-	-	-	-	-

All dimensions are in millimetres unless otherwise stated.

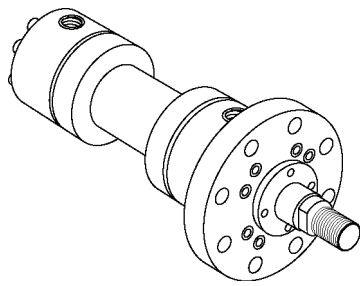

**Style MF3**  
Head Circular Flange

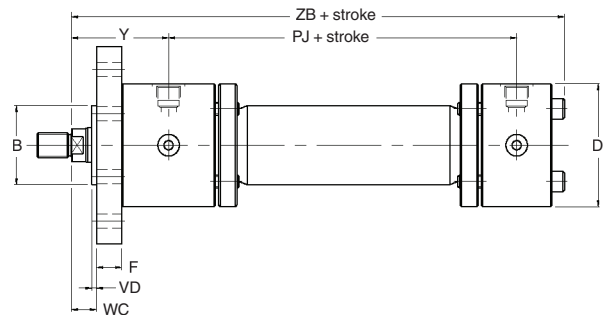
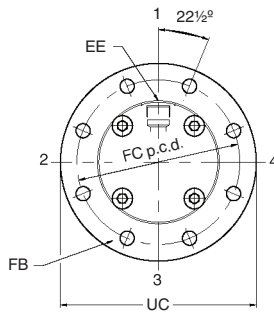

Accurate location of 'B' provided as standard on model MF3 only.

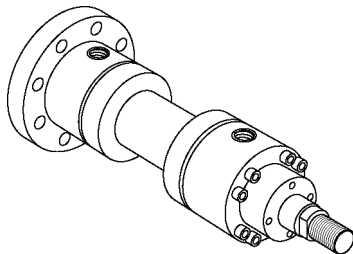

**Style MF4**  
Cap Circular Flange

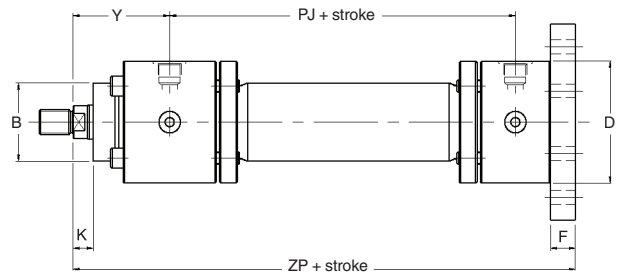
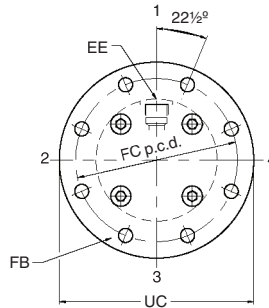

**Dimensions – MF3 and MF4** See also Rod End Dimensions, page 8

Bore Ø	Rod No.	MM Rod Ø	B f8	D max	EE (BSPP)	F	FB h13	FC js13	K	UC max	VD min	WC	Y	+ stroke		
														PJ	ZB max	ZP
40	1	22	50	78	G1/2	16	9	106	13	125	3	16	71	97	198	206
	2	28														
50	1	28	60	95	G1/2	20	11	126	14	148	4	18	72	111	213	225
	2	36														
63	1	36	70	116	G3/4	25	13.5	145	16	170	4	20	82	117	236	249
	2	45														
80	1	45	85	130	G3/4	32	17.5	165	18	195	4	22	91	134	262	282
	2	56														
100	1	56	106	158	G1	32	22	200	20	238	5	25	108	162	314	332
	2	70														
125	1	70	132	192	G1	32	22	235	23	272	5	28	121	174	341	357
	2	90														
160	1	90	160	232	G1 1/4	36	22	280	25	316	5	30	143	191	386	406
	2	110														
200	1	110	200	285	G1 1/4	40	26	340	30	385	5	35	190	224	466	490
	2	140														
250	1	140	250	365	G1 1/2	56	33	420	32	500	8	40	205	290	570	606
	2	180														
320	1	180	320	450	G1 1/2	63	39	520	37	600	8	45	250	358	684	723
	2	220														

All dimensions are in millimetres unless otherwise stated.

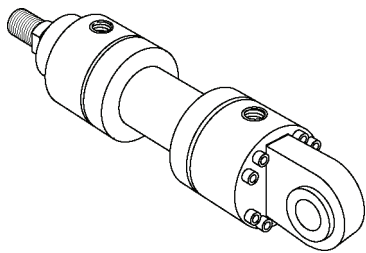

**Style MP3**  
Cap Fixed Eye

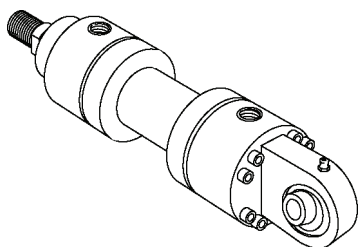
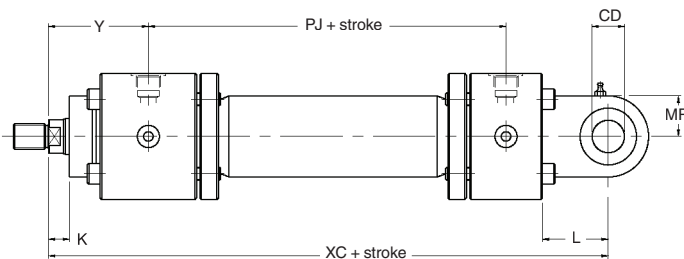
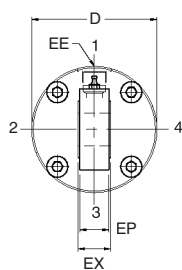

**Style MP5**  
Cap Fixed Eye  
with Spherical Bearing

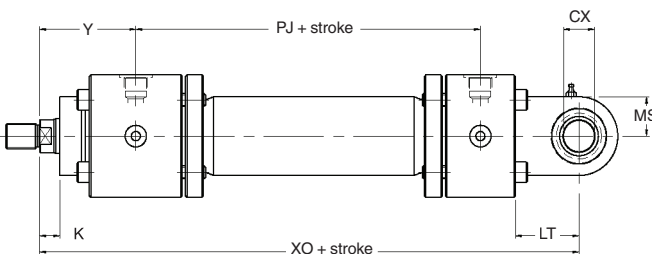
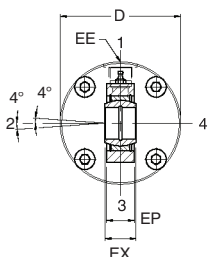

**Dimensions – MP3 and MP5** See also Rod End Dimensions, page 8

Bore Ø	Rod No.	MM Rod Ø	CD <sup>H9</sup> & CX <sup>H7</sup>	D max	EE (BSPP)	EP	EX h12	K	L & LT	MR & MS	Y	+ stroke	
												PJ	XC & XO
40	1	22	20	78	G <sup>1</sup> / <sub>2</sub>	18	20	13	41	25	71	97	231
	2	28											
50	1	28	25	95	G <sup>1</sup> / <sub>2</sub>	22	25	14	52	32	72	111	257
	2	36											
63	1	36	32	116	G <sup>3</sup> / <sub>4</sub>	27	32	16	65	40	82	117	289
	2	45											
80	1	45	40	130	G <sup>3</sup> / <sub>4</sub>	35	40	18	82	50	91	134	332
	2	56											
100	1	56	50	158	G1	40	50	20	95	63	108	162	395
	2	70											
125	1	70	63	192	G1	52	63	23	103	71	121	174	428
	2	90											
160	1	90	80	232	G <sup>1</sup> / <sub>4</sub>	66	80	25	135	90	143	191	505
	2	110											
200	1	110	100	285	G <sup>1</sup> / <sub>4</sub>	84	100	30	165	112	190	224	615
	2	140											
250	1	140	125	365	G <sup>1</sup> / <sub>2</sub>	102	125	32	223	160	205	290	773
	2	180											
320	1	180	160	450	G <sup>1</sup> / <sub>2</sub>	130	160	37	270	200	250	358	930
	2	220											

All dimensions are in millimetres unless otherwise stated.



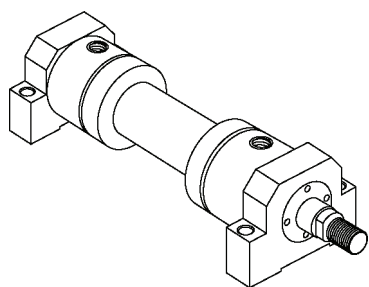

**Style MS2**  
 Foot Mounting

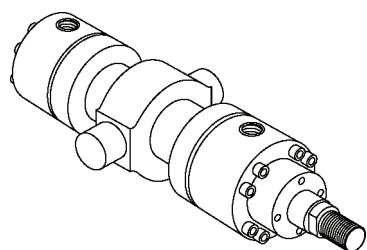
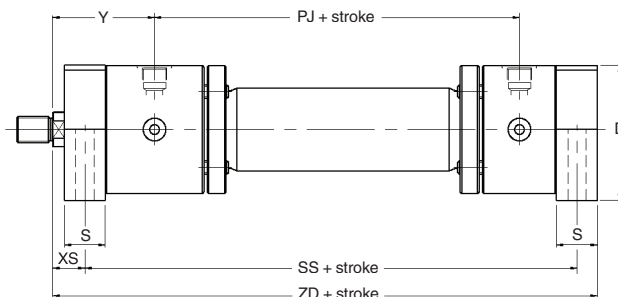
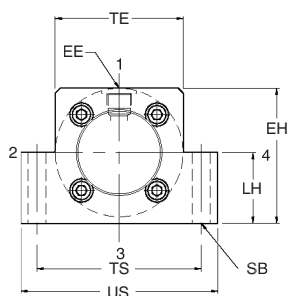

**Style MT4**  
 Intermediate Fixed Trunnion

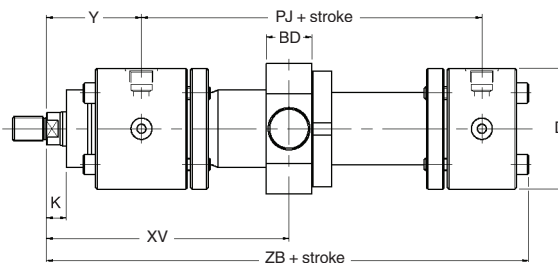
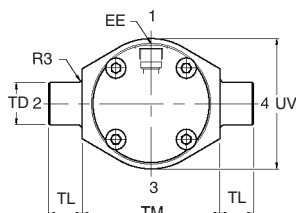

**Note:** XV Dimension to be specified by customer. Where the minimum dimension is unacceptable, please consult the factory.

**Dimensions – MS2 and MT4** See also Rod End Dimensions, page 8

Bore Ø	Rod No.	MM Rod Ø	BD max	D & TE max	EE (BSPP)	EH	K	LH h10	S	SB H13	TD f8	TL js15	TM h12	TS Js13	US	UV max	XS	XV min	Y	Min. Stroke MT4	+ stroke				
																					PJ	SS	XV max	ZB max	ZD
40	1 2	22 28	30	78	G <sup>1</sup> / <sub>2</sub>	82	13	43	25	11	20	16	90	100	120	78	19.5	130	71	37	97	183	93	198	215
50	1 2	28 36	35	95	G <sup>1</sup> / <sub>2</sub>	100	14	52	32	14	25	20	105	120	145	95	22	142	72	40	111	199	102	213	237
63	1 2	36 45	45	116	G <sup>3</sup> / <sub>4</sub>	120	16	62	32	18	32	25	120	150	180	116	29	160	82	53	117	211	107	236	256
80	1 2	45 56	50	130	G <sup>3</sup> / <sub>4</sub>	135	18	70	40	22	40	32	135	170	210	130	34	180	91	53	134	236	122	262	290
100	1 2	56 70	60	158	G1	161	20	82	50	26	50	40	160	205	250	158	32	210	108	58	162	293	152	314	350
125	1 2	70 90	75	192	G1	196	23	100	56	33	63	50	195	245	300	195	32	235	121	78	174	321	157	341	381
160	1 2	90 110	90	232	G <sup>1</sup> / <sub>4</sub>	238	25	119	60	33	80	63	240	295	350	240	36	273	143	96	191	364	177	386	430
200	1 2	110 140	110	285	G <sup>1</sup> / <sub>4</sub>	288	30	145	72	39	100	80	295	350	415	390	39	337	190	70	224	447	267	466	522
250	1 2	140 180	135	365	G <sup>1</sup> / <sub>2</sub>	-	32	-	-	-	125	100	370	-	-	480	-	393	205	95	290	-	298	570	-
320	1 2	180 220	175	450	G <sup>1</sup> / <sub>2</sub>	-	37	-	-	-	160	125	470	-	-	600	-	486	250	116	358	-	370	684	-

All dimensions are in millimetres unless otherwise stated.

**Piston Rod End Styles**

MMB cylinders are supplied with standard metric male and female rod ends to ISO 4395. They can also be supplied with other rod end threads, eg: ISO metric coarse, Unified, British Standard etc., or to the customer's special requirements.

Each cylinder bore size is offered with two diameters of piston rod – the smaller is designated No.1 and the larger, No.2. The standard male rod end threads, to ISO 6020/1, are designated Style 4 and female threads are designated Style 4.

Orders for non-standard rod ends, designated Style 3, should include dimensioned sketches and descriptions, showing dimensions KK or KF, A or WF, and the thread form required.

**Style 7**

To obtain a rod eye with the same pin diameter as fitted to the cylinder cap end of mounting styles MP3 and MP5 with No.2 rod, a Style 7 rod end should be specified.

**Wrench Flats**

Piston rods up to and including 140mm in diameter are supplied with the wrench flats D shown in the table below. Rods above 140mm in diameter feature four drilled holes to accept a pin wrench.

**Rod End Styles 4 & 7**

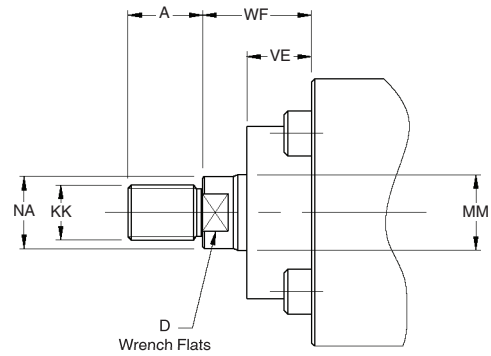

**Rod End Style 9**

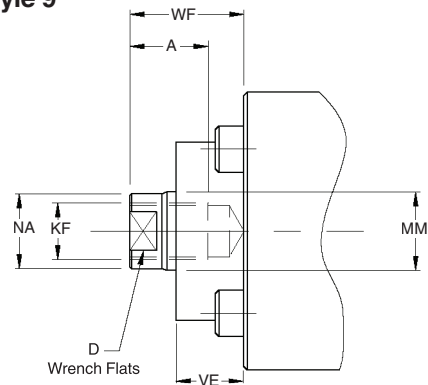

**Rod End Dimensions**

Bore Ø	Rod No.	MM Rod Ø	Style 4		Style 7		Style 9		D	NA	VE	WF
			KK	A	KK	A	KF	A				
40	1	22					M16x1.5	22	18	21	19	32
	2	28			M16x1.5	22	M20x1.5	28	22	26		
50	1	28					M20x1.5	28	22	26	24	38
	2	36			M20x1.5	28	M27x2	36	30	34		
63	1	36					M27x2	36	30	34	29	45
	2	45			M27x2	36	M33x2	45	39	43		
80	1	45					M33x2	45	39	43	36	54
	2	56			M33x2	45	M42x2	56	48	54		
100	1	56					M42x2	56	48	54	37	57
	2	70			M42x2	56	M48x2	63	62	68		
125	1	70					M48x2	63	62	68	37	60
	2	90			M48x2	63	M64x3	85	80	88		
160	1	90					M64x3	85	80	88	41	66
	2	110			M64x3	85	M80x3	95	100	108		
200	1	110					M80x3	95	100	108	45	75
	2	140			M80x3	95	M100x3	112	128	138		
250	1	140					M100x3	112	128	138	64	96
	2	180			M100x3	112	M125x4	125	-	175		
320	1	180					M125x4	125	-	175	71	108
	2	220			M125x4	125	M160x4	160	-	214		

All dimensions are in millimetres unless otherwise stated.



**Rod Eye with Spherical Bearing – ISO 6982**

**Rod Eye with Plain Bearing – ISO 6981**

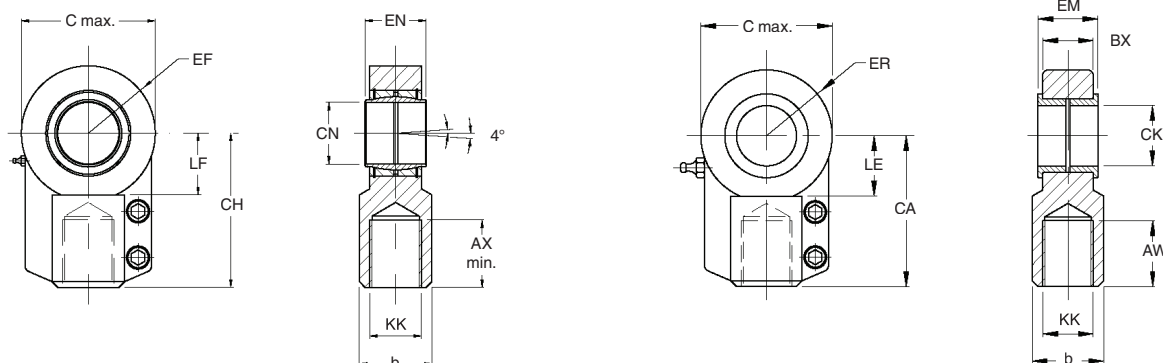

**Dimensions** See also Rod End Dimensions, page 8

Bore Ø	KK	Spherical Bearing Part No.	Plain Bearing Part No.	AX & AW min	b	BX	C max	CA & CH	CK <sup>H9</sup> & CN <sup>H7</sup>	EF & ER	EM <sup>h12</sup> & EN <sup>h12</sup>	LE & LF	Nominal force kN	Mass kg
40	M16x1.5	145239	148729	23	25	17	47	52	20	25	20	22	20	0.4
50	M20x1.5	145240	148730	29	30	21	58	65	25	32	25	27	32	0.7
63	M27x2	145241	148731	37	38	27	70	80	32	40	32	32	50	1.2
80	M33x2	145242	148732	46	47	32	89	97	40	50	40	41	80	2.1
100	M42x2	145243	148733	57	58	40	108	120	50	63	50	50	125	4.4
125	M48x2	145244	148734	64	70	52	132	140	63	71	63	62	200	7.6
160	M64x3	145245	148735	86	90	66	168	180	80	90	80	78	320	14.5
200	M80x3	148724	148737	96	110	84	210	210	100	112	100	98	500	28
250	M100x3	148726	148739	113	135	102	262	260	125	160	125	120	800	43
320	M125x4	148727	148740	126	165	130	326	310	160	250	160	150	1250	80

**Note:** To obtain the same pin diameter at the head and cap ends of pivot-mounted cylinders (Styles MP3 and MP5), a style 4 rod end should be specified with a No.1 rod, and a style 7 rod end should be specified with a No.2 rod. This ensures that the correct rod end thread is supplied to accept the appropriate spherical bearing or plain bearing rod eye – see Rod End Dimensions, page 8.

**Trunnion Block – ISO 8132**

Bore Ø	Part Number	CO N9	CR H7	FK js12	FN max	FS js14	HB H13	KC +0.3	NH max	TH js14	UL max	Nominal Force kN
40	149333	16	20	45	70	10	11	4.3	21	60	90	20
50	149334	25	25	55	80	12	13.5	5.4	26	80	110	32
63	149335	25	32	65	100	15	17.5	5.4	33	110	150	50
80	149336	36	40	76	120	16	22	8.4	41	125	170	80
100	149337	36	50	95	140	20	26	8.4	51	160	210	125
125	149338	50	63	112	180	25	33	11.4	61	200	265	200
160	149339	50	80	140	220	31	39	11.4	81	250	325	320

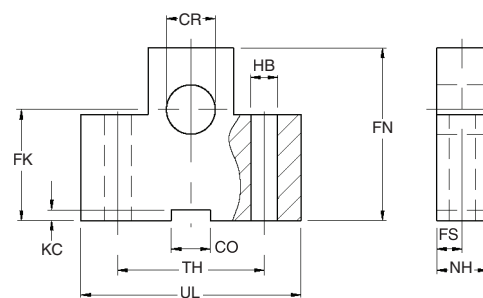

All dimensions are in millimetres unless otherwise stated.

**Calculation of Cylinder Diameter**

If the piston rod is in compression, use the 'Push Force' table.

1. Identify the operating pressure closest to that required.
2. In the same column, identify the force required to move the load (always rounding up).
3. In the same row, look along to the cylinder bore required.

If the cylinder envelope dimensions are too large, increase the operating pressure, if possible, and repeat the exercise.

**Push Force**

Bore Ø mm	Cylinder Bore Area mm <sup>2</sup>	Cylinder Push Force in kN					
		10 Bar	40 Bar	63 Bar	100 Bar	125 Bar	160 Bar
40	1257	1.3	5.0	7.9	12.6	15.7	20.1
50	1964	2.0	7.9	12.4	19.6	24.6	31.4
63	3118	3.1	12.5	19.6	31.2	39.0	49.9
80	5027	5.0	20.1	31.7	50.3	62.8	80.4
100	7855	7.9	31.4	49.5	78.6	98.2	126
125	12272	12.3	49.1	77.3	123	153	196
160	20106	20.1	80.4	127	201	251	322
200	31416	31.4	126	198	314	393	503
250	49087	49.1	196	309	491	614	785
320	80425	80.4	322	507	804	1005	1287

If the piston rod is in tension, use the 'Deduction for Pull Force' table. To determine the pull force:

1. Follow the procedure given for 'push' applications, as described above.
2. Using the 'Deduction for Pull Force' table below, establish the appropriate reduction in force.
3. Deduct this from the original 'Push' force. The resultant is the net force available to move the load.

If this force is not large enough, repeat the process with a higher system operating pressure or cylinder diameter.

**Deduction for Pull Force**

Piston Rod Ø mm	Piston Rod Area mm <sup>2</sup>	Reduction in Force in kN					
		10 Bar	40 Bar	63 Bar	100 Bar	125 Bar	160 Bar
22	380	0.4	1.5	2.4	3.8	4.8	6.1
28	616	0.6	2.5	3.9	6.2	7.7	9.9
36	1018	1.0	4.1	6.4	10.2	12.7	16.3
45	1590	1.6	6.4	10.0	15.9	19.9	25.5
56	2463	2.5	9.9	15.6	24.6	30.8	39.4
70	3848	3.8	15.4	24.2	38.5	48.1	61.6
90	6362	6.4	25.5	40.1	63.6	79.6	102
110	9503	9.5	38.0	59.9	95.1	119	152
140	15394	15.4	61.6	97.0	154	193	246
180	25447	25.4	102	160	254	318	407
220	38013	38.0	152	240	380	475	608

**inPHorm**

For assistance with the calculation of cylinder bore size, refer to the inPHorm selection program (1260/Eur).

**Mounting Information**

**Mounting Bolts**

Mounting bolts with a strength to ISO 898/1 grade 12.9 should be used for attaching cylinders. Bolts should be torque loaded to their manufacturer's recommended figures.

**Head and Cap  
Retention Bolts**

If damage or corrosion is found on removal, replacement bolts with a minimum strength to ISO 898/1 grade 12.9 must be fitted. Head and cap bolts should be torque tightened progressively in a diagonal sequence to the figures shown in the table.

Bore Ø mm	Flange Bolts	
	Torque Load (Nm)	Bolt Size
40	36	M8
50		
63		
80	123	M12
100		
125	196	M14
160		
200		
250	305	M16
320		
	595	M20
	1030	M24

**Gland and Piston Seal Options See page 17  
Standard Option**

The standard seals fitted to MMB cylinders may be used with all fluid groups (see page 15) at piston speeds up to 0.5m/s. The gland seals comprise a heavy duty lipseal and wiperseal for efficient sealing, while the pistons are fitted with a heavy duty filled polymer seal and wear rings which prevent metal contact with the cylinder bore and help to protect the piston seal from contaminants.

**Load Holding Option**

Suitable for applications where loads are required to be held in position, the Load Holding option combines standard gland seals (see above) with chevron pistons which feature a two-piece piston with a wide bearing ring mounted between chevron seals. The load holding option may be used for piston speeds up to 0.5m/s.

**Chevron Option**

Suitable for harsh environments such as steel mills, chevron seals may also be used to hold a load in position. They are suitable for use with all fluid groups and for piston speeds up to 0.5m/s. Chevron gland seals have a steel retainer, and a separate removable steel housing which retains the inner bearing rings. A heavy duty wiper seal prevents the ingress of contaminants. Chevron pistons feature a two-piece piston with a wide bearing ring mounted between chevron seals.

**Piston Rod Size Selection**

To select a piston rod for thrust (push) conditions:

1. Determine the mounting style and rod end connection to be used. Consult the Stroke Factor table on page 12 and identify the appropriate factor for the application.
2. Using this stroke factor, determine the 'basic length' from the equation:

$$\text{Basic Length} = \text{Net Stroke} \times \text{Stroke Factor}$$

(The Piston Rod Selection Chart, below, is prepared for the standard rod extension beyond the face of the gland retainer. For rod extensions greater than standard, add the increase to the stroke to arrive at the 'basic length'.)

3. Find the load imposed for the thrust application by multiplying the full bore area of the cylinder by the system pressure, or by referring to the Push and Pull Force tables on page 10.
4. Using the Piston Rod Selection Chart below, look along the values of 'basic length' and 'thrust' as found in 2. and 3. above, and note the point of intersection.

The correct piston rod diameter is read from the curved line **above** the point of intersection.

For tensile (pull) loads, the rod size is selected by specifying standard cylinders with standard rod diameters and using them at or below the rated pressure.

**Long Strokes and Stop Tubes**

For long stroke cylinders under compressive loads, the use of a stop tube should be considered, to reduce bearing stress. Selection of a stop tube is described on page 12.

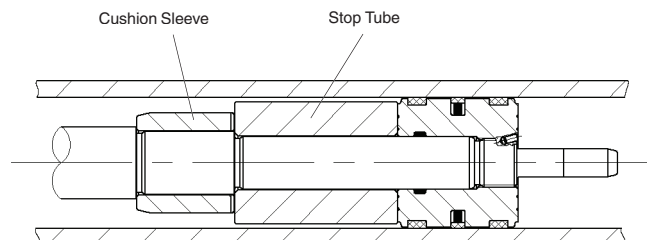

**inPHorm**

For more accurate sizing, please refer to the European cylinder inPHorm selection program (1260/Eur).

**Piston Rod Selection Chart**

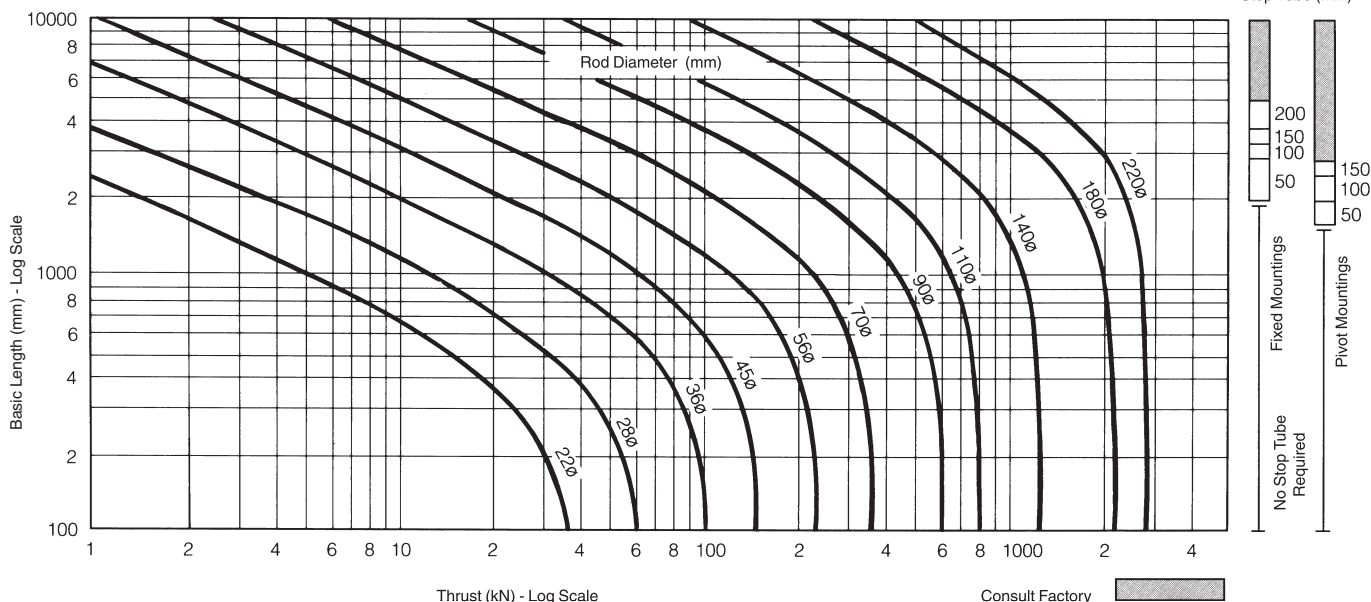

All dimensions are in millimetres unless otherwise stated.

**Stop Tubes**

The Piston Rod Selection Chart on page 11 indicates where the use of a stop tube should be considered. The required length of stop tube, where necessary, is read from the vertical columns on the right of the chart, by following the horizontal band within which the point of intersection lies. Note that stop tube requirements differ for fixed and pivot mounted cylinders.

When specifying a cylinder with a stop tube, please insert an S (Special) and the net stroke of the cylinder in the order code and state the length of the stop tube. Note that net stroke is equal to the gross stroke of the cylinder less the length of the stop tube. The gross stroke determines the envelope dimensions of the cylinder.

If the required length of stop tube is in the shaded region marked 'consult factory', please submit the following information.

1. Cylinder mounting style.
2. Rod end connection and method of guiding the load.
3. Bore and stroke required, and length of rod extension (Dimension 'K') if greater than standard.
4. Mounting position of cylinder. If at an angle or vertical, specify the direction of the piston rod.
5. Operating pressure of the cylinder if limited to less than the standard pressure for the cylinder selected.

**inPHorm**

For accurate sizing, please refer to the European cylinder inPHorm selection program (1260/Eur).

**Stroke Factor Selection**

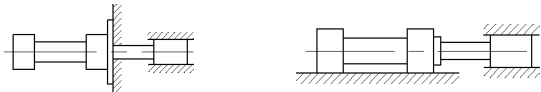
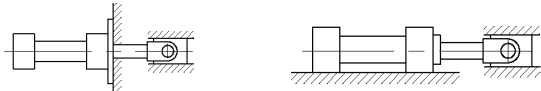
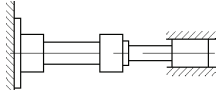
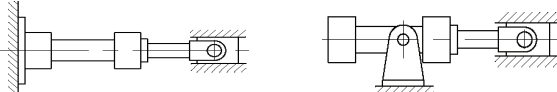
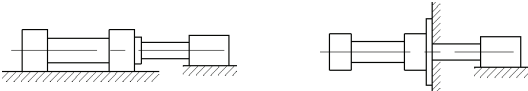
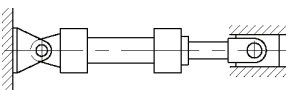
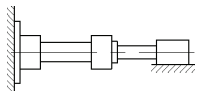
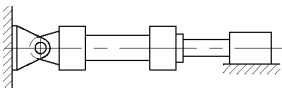
Rod End Connection	Style	Type of Mounting	Stroke Factor
Fixed and Rigidly Guided	MF1 MF3 MS2		0.5
Pivoted and Rigidly Guided	MF1 MF3 MS2		0.7
Fixed and Rigidly Guided	MF2 MF4		1.0
Pivoted and Rigidly Guided	MF2 MF4 MT4		1.5
Supported but Not Rigidly Guided	MF1 MF3 MS2		2.0
Pivoted and Rigidly Guided	MP3 MP5		2.0
Supported but Not Rigidly Guided	MF2 MF4		4.0
Supported but Not Rigidly Guided	MP3 MP5		4.0

**An Introduction to Cushioning**

Cushioning is recommended as a means of controlling the deceleration of masses, or for applications where piston speeds are in excess of 0.1m/s and the piston will make a full stroke. Cushioning extends cylinder life and reduces undesirable noise and hydraulic shock.

Built-in deceleration devices or 'cushions' are optional and can be supplied at the head and/or cap ends of the cylinder without affecting its envelope or mounting dimensions. Cushions are adjustable via recessed needle valves.

**Standard Cushioning**

Ideal cushion performance shows an almost uniform absorption of energy along the cushion's length. Where specified, MMB cylinders uses profiled cushions which give a performance that comes close to the ideal in the majority of applications. The head and cap cushion performance for each bore size is illustrated in the charts on page 14.

**Alternative Forms of Cushioning**

Special designs can be produced to suit applications where the energy to be absorbed exceeds the performance of the standard cushion. Please consult the factory for details.

**Cushion Length**

All MMB cylinder cushions incorporate the longest cushion sleeve and spear that can be provided in the standard envelope without decreasing the rod bearing and piston bearing lengths – see table of cushion lengths on page 14.

**Cushion Calculations**

The charts on page 14 show the energy absorption capacity for each bore and rod combination at the head (annulus) and the cap (full bore) ends of the cylinder. The charts are valid for piston velocities in the range 0.1 to 0.3m/s. For velocities between 0.3 and 0.5m/s, the energy values from the charts should be reduced by 25%. For velocities of less than 0.1m/s where large masses are involved, and for velocities greater than 0.5m/s, a special cushion profile may be required. Please consult the factory.

The cushion capacity of the head end is less than that of the cap, owing to the pressure intensification effect across the piston.

The energy absorption capacity of the cushion decreases with drive pressure, which in normal circuits is the relief valve setting.

**inPHorm**

Cushioning requirements can be calculated automatically for individual cylinder/load combinations using the European cylinder inPHorm selection program (1260/Eur).

**Formulae**

Cushioning calculations are based on the formula  $E = \frac{1}{2}mv^2$  for horizontal applications. For inclined or vertically downward or upward applications, this is modified to:

$$E = \frac{1}{2}mv^2 + mgl \times 10^{-3} \times \sin\alpha$$

- for inclined/vertically downward direction of mass (head end)
- for inclined/vertically upward direction of mass (cap end)

$$E = \frac{1}{2}mv^2 - mgl \times 10^{-3} \times \sin\alpha$$

- for inclined/vertically upward direction of mass (head end)
- for inclined/vertically downward direction of mass (cap end)

Where:

- E = energy absorbed in Joules
- g = acceleration due to gravity = 9.81m/s<sup>2</sup>
- v = velocity in metres/second
- l = length of cushion in millimetres (see page 14)
- m = mass of load in kilogrammes (including piston, rod and rod end accessories, see pages 9 and 14)
- α = angle to the horizontal in degrees
- p = pressure in bar

**Example**

The example shows how to calculate the energy developed by masses moving in a straight line. For non-linear motion, other calculations are required; please consult the factory.

The example assumes that the bore and rod diameters are appropriate for the application. The effects of friction on the cylinder and load have been ignored.

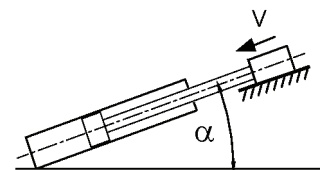

Selected bore/rod – 125/90mm (No.2 rod). Cushioning at head.

- Pressure = 160 bar
- Mass = 10000kg
- Velocity = 0.5m/s
- Cushion length = 40mm
- α = 15°
- Sinα = 0.26

$$E = \frac{1}{2}mv^2 - mgl \times 10^{-3} \times \sin\alpha$$

$$E = \frac{10000 \times 0.5^2}{2} - 10000 \times 9.81 \times \frac{40}{10^3} \times 0.26$$

$$E = 1250 - 1020 = 230 \text{ Joules}$$

Note that, as velocity is greater than 0.3m/s, the energy absorption figures obtained from the charts on page 14 should be reduced by 25% – see Cushion Calculations, opposite. Comparison with the cushioning chart curve for this cylinder shows an energy capacity for the head end of 400 Joules. Reducing this by 25% gives a capacity of 300 Joules, so the standard cushion can safely decelerate the 230 Joules in this example.

Where cushion performance figures are critical, our engineers can run a computer simulation to determine accurate cushion performance – please contact the factory for details.

**Cushion Energy Absorption Capacity Data**

The cushion energy absorption capacity data shown below are based on the maximum fatigue-free pressure developed in the tube. If working life cycle applications of less than 10<sup>6</sup> cycles

are envisaged, then greater energy absorption figures can be applied. Please consult the factory for further information.

**Head End, No.1 and No.2 Rods**

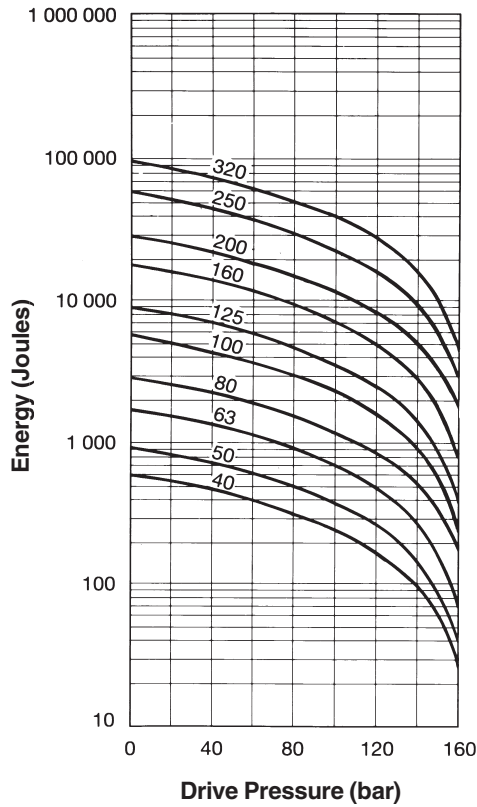

**Cap End, No.1 and No.2 Rods**

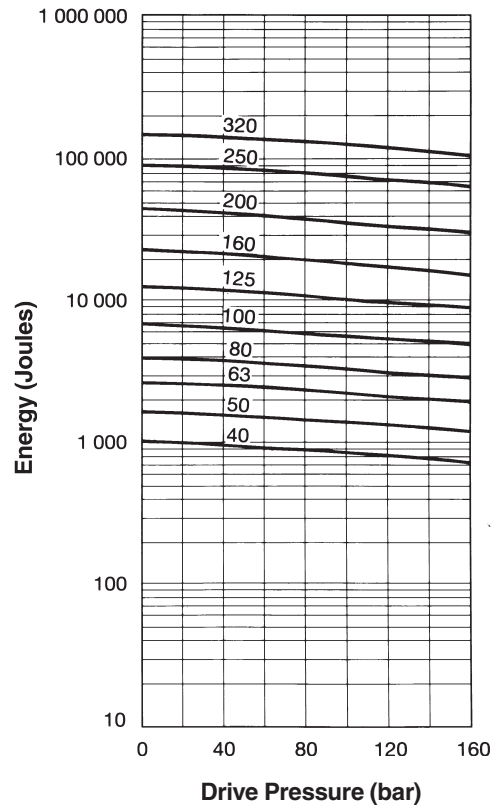

**Cushion Length**

Bore Ø	Rod No.	Cushion Length	
		Head	Cap
40	1	30	30
	2		
50	1	30	30
	2		
63	1	30	30
	2		
80	1	35	35
	2		
100	1	35	35
	2		
125	1	40	40
	2		
160	1	40	40
	2		
200	1	45	45
	2		
250	1	45	45
	2		
320	1	50	50
	2		

**Piston and Rod Mass**

Bore Ø	Rod No.	Rod Ø	Piston & Rod at Zero Stroke (kg)	
			Piston & Rod at Zero Stroke (kg)	Rod Only per 10mm Stroke (kg)
40	1	22	0.7	0.03
	2	28	1.0	0.05
50	1	36	1.3	0.08
	2			
63	1	45	2.3	0.12
	2			
80	1	56	2.9	0.19
	2			
100	1	70	4.3	0.30
	2			
125	1	90	5.6	0.50
	2			
160	1	110	8.5	0.75
	2			
200	1	140	11	1.2
	2			
250	1	180	15	2.0
	2			
320	1	220	21	3.0
	2			

All dimensions are in millimetres unless otherwise stated.



### Seals and Fluid Data

Fluid Group	Seal Materials – a combination of:	Fluid Medium to ISO 6743/4-1982	Temperature Range
1	Nitrile (NBR), PTFE, enhanced polyurethane (AU)	Mineral Oil HH, HL, HLP, HLP-D, HM, HV, MIL-H-5606 oil, air, nitrogen	-20°C to +80°C
2	Nitrile (NBR), PTFE	Water glycol (HFC)	-20°C to +60°C
5	Fluorocarbon elastomer (FPM), PTFE	Fire resistant fluids based on phosphate esters (HFD-R) Also suitable for hydraulic oil at high temperatures or in hot environments. <b>Not suitable for use with Skydrol.</b> See fluid manufacturer's recommendations.	-20°C to +150°C
6	Various compounds including nitrile, enhanced polyurethane, fluorocarbon elastomers and PTFE	Water Oil in water emulsion 95/5 (HFA)	+5°C to +55°C
7		Water in oil emulsion 60/40 (HFB)	+5°C to +60°C

### Special Seals

A range of seal options is available for each of the fluid groups listed above – see cylinder model numbers on page 19. Where required, special seals can also be supplied. Please insert an S (Special) in the model number and specify fluid medium when ordering.

### Group 6 Seal Life

Seals used with High Water Content Fluids (HFA) are subject to wear due to the poor lubricity of the operating medium. This problem increases with pressure.

### Low Friction Applications

For applications where very low friction and an absence of stick-slip are important, low friction seals are available. For details, please consult the factory.

### Water Service

Special modifications such as a stainless steel piston rod and plating of internal surfaces are available for high water content fluids. When ordering, please specify the maximum operating pressure or load/speed conditions, as the stainless steel rod is of lower tensile strength than the standard material.

### Warranty

Parker Hannifin warrants cylinders modified for water or high water content fluid service to be free of defects in materials and workmanship, but cannot accept responsibility for premature failure caused by excessive wear resulting from lack of lubricity, or where failure is caused by corrosion, electrolysis or mineral deposits within the cylinder.

### Filtration

Fluid cleanliness should be in accordance with ISO 4406. The quality of filters should be in accordance with the appropriate ISO standards.

The rating of the filter media depends on the system components and the application. The minimum required for hydraulic systems should be class 19/15 to ISO 4406, which equates to 25µ ( $\beta_{10} \geq 75$ ) to ISO 4572.

### Cylinder Masses

The following table shows the masses of MMB cylinders for each mounting style at zero stroke; a stroke adder for each 10mm of stroke can then be calculated. Where applicable, accessory masses can be added to give a gross mass for the complete assembly – see page 9.

Bore Ø	Rod No.	Mounting Styles at Zero Stroke, in kg					per 10mm Stroke kg
		MF1, MF2	MF3, MF4	MP3, MP5	MS2	MT4	
40	1	6.72	7.13	6.27	8.27	6.64	0.08
	2	6.75	7.16	6.30	8.30	6.67	0.10
50	1	10.77	11.38	10.00	13.75	10.41	0.15
	2	10.81	11.42	10.04	13.79	10.45	0.18
63	1	17.95	18.75	16.71	22.06	17.60	0.23
	2	18.02	18.82	16.78	22.13	17.67	0.27
80	1	25.4	26.9	24.2	31.7	24.0	0.34
	2	25.5	27.0	24.3	31.8	24.1	0.41
100	1	44.3	46.5	43.3	56.4	43.1	0.53
	2	44.5	46.7	43.5	56.6	43.3	0.64
125	1	69.0	71.2	69.3	90.4	70.3	0.76
	2	69.4	71.6	69.7	90.8	70.7	0.96
160	1	–	117.2	119.9	147.3	118.2	1.22
	2	–	117.8	120.5	147.9	118.8	1.46
200	1	–	214.6	225.2	266.3	219.7	1.81
	2	–	216.0	226.6	267.7	221.1	2.26
250	1	–	438.3	462.6	–	432.7	2.81
	2	–	440.8	465.1	–	435.2	3.59
320	1	–	802.8	866.8	–	824.7	3.98
	2	–	829.7	893.7	–	851.6	4.96



**Port Size and Piston Speed**

Fluid velocity in connecting lines should be limited to 5m/s to minimise fluid turbulence, pressure loss and 'water hammer' effects. The tables below show piston speeds for standard and oversize ports and connecting lines where the velocity of fluid is 5m/s. If the desired piston speed results in a fluid flow in excess of 5m/s in connecting lines, larger lines with two ports per cap should be considered. Parker recommends that a flow rate of 12m/s in connecting lines should not be exceeded.

**Note:** Consult the factory if piston speed is to exceed 0.5m/s.

Bore Ø mm	Standard Cylinder Port			
	Port size (BSPP)	Bore of Connecting Lines mm	Cap End Flow in l/min at 5m/s	Piston Speed m/s
40	G <sup>1</sup> / <sub>2</sub>	13	40	0.53
50	G <sup>1</sup> / <sub>2</sub>	13	40	0.34
63	G <sup>3</sup> / <sub>4</sub>	15	53	0.28
80	G <sup>3</sup> / <sub>4</sub>	15	53	0.18
100	G1	19	85	0.18
125	G1	19	85	0.12
160	G1 <sup>1</sup> / <sub>4</sub>	24	136	0.11
200	G1 <sup>1</sup> / <sub>4</sub>	24	136	0.07
250	G1 <sup>1</sup> / <sub>2</sub>	30	212	0.07
320	G1 <sup>1</sup> / <sub>2</sub>	30	212	0.04

Bore Ø mm	Oversize Cylinder Port			
	Port size (BSPP)	Bore of Connecting Lines mm	Cap End Flow in l/min at 5m/s	Piston Speed m/s
40	G <sup>3</sup> / <sub>4</sub>	15	53	0.70
50	G <sup>3</sup> / <sub>4</sub>	15	53	0.45
63	G1	19	85	0.45
80	G1	19	85	0.28
100	G1 <sup>1</sup> / <sub>4</sub>	24	136	0.29
125	G1 <sup>1</sup> / <sub>4</sub>	24	136	0.18
160	G1 <sup>1</sup> / <sub>2</sub>	30	212	0.17
200	G1 <sup>1</sup> / <sub>2</sub>	30	212	0.11
250	G2	38	340	0.11
320	G2	38	340	0.07

**Port Types**

In addition to the standard and oversize BSPP ports, metric threaded ports to DIN 3852 Pt. 1 and ISO 6149, and flange ports to ISO 6162 can also be supplied – see tables below.

The ISO 6149 port incorporates a raised ring in the spot face for identification. Other flange port styles are available on request.

Bore Ø mm	Standards Ports			Oversize Ports		
	BSPP	Metric	DN Flange	BSPP	Metric	DN Flange
40	G <sup>1</sup> / <sub>2</sub>	M22x1.5	–	G <sup>3</sup> / <sub>4</sub>	M27x2	–
50	G <sup>1</sup> / <sub>2</sub>	M22x1.5	–	G <sup>3</sup> / <sub>4</sub>	M27x2	–
63	G <sup>3</sup> / <sub>4</sub>	M27x2	13	G1	M33x2	–
80	G <sup>3</sup> / <sub>4</sub>	M27x2	13	G1	M33x2	–
100	G1	M33x2	19	G1 <sup>1</sup> / <sub>4</sub>	M42x2	25
125	G1	M33x2	19	G1 <sup>1</sup> / <sub>4</sub>	M42x2	25
160	G1 <sup>1</sup> / <sub>4</sub>	M42x2	25	G1 <sup>1</sup> / <sub>2</sub>	M48x2	32
200	G1 <sup>1</sup> / <sub>4</sub>	M42x2	25	G1 <sup>1</sup> / <sub>2</sub>	M48x2	32
250	G1 <sup>1</sup> / <sub>2</sub>	M48x2	32	G2	M60x2	38
320	G1 <sup>1</sup> / <sub>2</sub>	M48x2	32	G2	M60x2	38

**Flange Port Sizes**

Bore Ø mm	Standard Flange Port					
	DN Flange	A	EA	EB	ED	FF Ø
63	13	51	17.5	38.1	M8x1.25	13
80		58				
100	19	71	22.2	47.6	M10x1.5	19
125		89				
160	25	110	26.2	52.4	M10x1.5	25
200		137				
250	32	177	30.2	58.7	M10x1.5	32
320		220				

Bore Ø mm	Oversize Flange Port					
	DN Flange	A	EA	EB	ED	FF Ø
100	25	69	26.2	52.4	M10x1.5	25
125		87				
160	32	107	30.2	58.7	M10x1.5	32
200		135				
250	38 <sup>1</sup>	173	36.5	79.3	M16x2	38
320		217				

<sup>1</sup> 400 bar series

**Flange Ports**

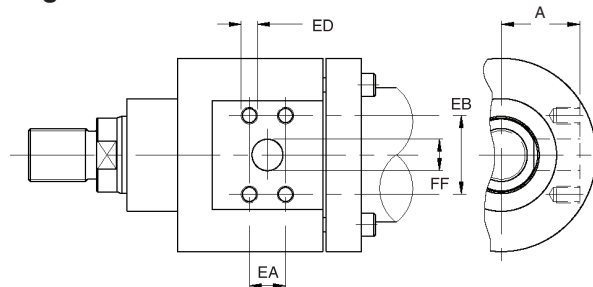

All dimensions are in millimetres unless otherwise stated.

**Service Assemblies and Seal Kits**

When ordering Service Assemblies and Seal Kits, please refer to the identification plate on the cylinder body, and supply the following information:

**Serial Number - Bore - Stroke - Model Number - Fluid Type**

**Key to Part Numbers**

- 1 Head
- 7 Cap
- 14 Standard gland
- 14a Chevron gland
- 14b Gland bearing
- 15 Cylinder tube
- 17 Standard piston
- 17a Chevron piston – head end
- 17b Chevron piston – cap end
- 18 Cushion sleeve
- 19 Front/rear flange
- 20 Cushion bush retaining ring
- 23 Head/cap securing screw

- 125 Standard piston seal
- 126 Energising ring for standard seal 125
- 127 Wear ring for standard piston
- 134<sup>1</sup> Back up washer (gland/head)
- 137 Chevron rod seal assembly
- 139a Wear ring for chevron gland
- 139b Wear rings for chevron gland
- 140a Wear ring for standard gland
- 140b Wear rings for standard gland
- 142 Chevron piston bearing ring
- 143 Chevron piston seal assembly

<sup>1</sup> In some cases, harder O-rings are supplied in place of the O-ring/back-up washer combination.

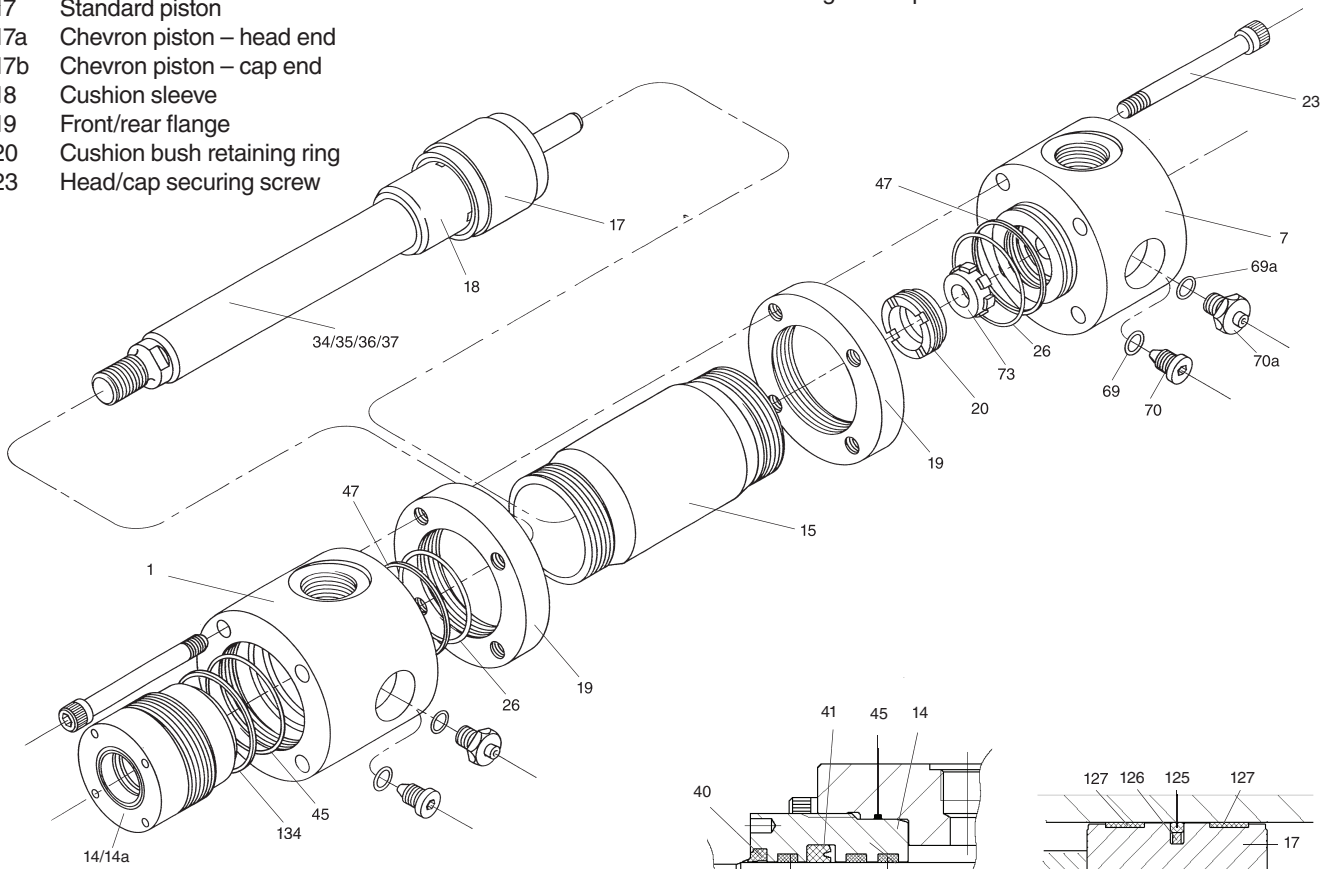

- 26 O-ring (cylinder body)
- 34 Piston rod – single rod, no cushion
- 35 Piston rod – single rod, cushion at head end
- 36 Piston rod – single rod, cushion at cap end
- 37 Piston rod – single rod, cushion at both ends
- 40 Gland wiperseal
- 41 Lipseal
- 45 O-ring (gland/head)
- 46 O-ring, piston/rod (2 off – chevron piston)
- 47 Back-up washer (cylinder body)
- 55 Piston locking pin
- 69 O-ring, cushion needle valve
- 69a O-ring, cartridge-type needle valve
- 70 Cushion needle valve
- 70a Cartridge-type needle valve
- 73 Floating cushion bush

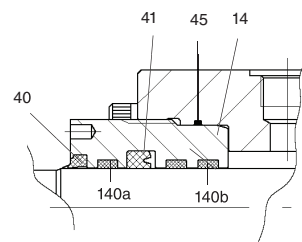

**Standard Gland & Seals**

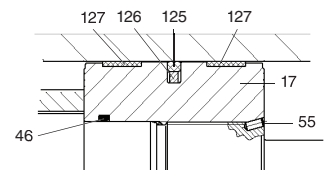

**Standard Piston**

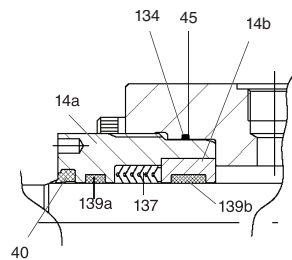

**Chevron Gland & Seals**

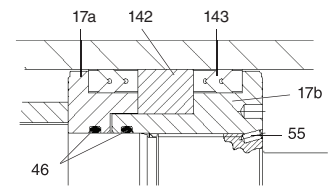

**Chevron Piston**

**Contents and Part Numbers of Seal Kits for Pistons and Glands**

(see key to part numbers opposite)

**RG Kit – Standard Gland Cartridge and Seals**  
Contains RK Kit, plus 14.

**RGL Kit – Chevron Gland Cartridge and Seals**  
Contains RKL Kit, plus 14a, 14b.

**RK Kit – Standard Gland Cartridge Seals**  
Contains items 40, 41, 45, 134, 140a, 140b.

**RKL Kit – Chevron Gland Cartridge Seals**  
Contains items 40, 45, 134, 137, 139a, 139b.

**CB Kit – Cylinder Body End Seals and Back-up Washers**  
Contains items 26 and 47.

**PN Kit – CB Kit plus seals for Standard Piston**  
Contains CB kit, plus 46, 125, 126, 127.

**PL Kit – CB Kit plus seals for Chevron Piston**  
Contains CB kit, plus 55, 142, 143 and two of 46.

**Seal Groups Ordering**

All part numbers listed contain standard, Group 1 seals. To order kits with other classes of seals, replace the last digit of the part number shown with the number of the seal group required. Eg: RG04MMB0221, containing a Group 1 seal, becomes RG04MMB0225 when it contains a Group 5 seal.

**Service Kit Order Codes – Piston and Body**

Bore Ø mm	CB Kit Body End Seals	PN Kit Standard Piston Seals	PL Kit Chevron Piston Seals
40	CB040MMB01	PN040MMB01	PL040MMB01
50	CB050MMB01	PN050MMB01	PL050MMB01
63	CB063MMB01	PN063MMB01	PL063MMB01
80	CB080MMB01	PN080MMB01	PL080MMB01
100	CB100MMB01	PN100MMB01	PL100MMB01
125	CB125MMB01	PN125MMB01	PL125MMB01
160	CB160MMB01	PN160MMB01	PL160MMB01
200	CB200MMB01	PN200MMB01	PL200MMB01
250	CB250MMB01	PN250MMB01	PL250MMB01
320	CB320MMB01	PN320MMB01	PL320MMB01

**Service Kit Order Codes – Glands**

Bore Ø	Rod Ø	RG Kit Standard Gland Cartridge and Seals	RGL Kit Chevron Gland Cartridge and Seals	RK Kit Standard Gland Cartridge Seals	RKL Kit Chevron Gland Cartridge Seals
40	22	RG04MMB0221	RGL04MMB0221	RK04MMB0221	RKL04MMB0221
	28	RG04MMB0281	RGL04MMB0281	RK04MMB0281	RKL04MMB0281
50	36	RG05MMB0281	RGL05MMB0281	RK05MMB0281	RKL05MMB0281
	45	RG05MMB0361	RGL05MMB0361	RK05MMB0361	RKL05MMB0361
63	56	RG06MMB0361	RGL06MMB0361	RK06MMB0361	RKL06MMB0361
	70	RG06MMB0451	RGL06MMB0451	RK06MMB0451	RKL06MMB0451
80	80	RG08MMB0451	RGL08MMB0451	RK08MMB0451	RKL08MMB0451
	90	RG08MMB0561	RGL08MMB0561	RK08MMB0561	RKL08MMB0561
100	100	RG10MMB0561	RGL10MMB0561	RK10MMB0561	RKL10MMB0561
	110	RG10MMB0701	RGL10MMB0701	RK10MMB0701	RKL10MMB0701
125	125	RG12MMB0701	RGL12MMB0701	RK12MMB0701	RKL12MMB0701
	140	RG12MMB0901	RGL12MMB0901	RK12MMB0901	RKL12MMB0901
160	160	RG16MMB0901	RGL16MMB0901	RK16MMB0901	RKL16MMB0901
	180	RG16MMB1101	RGL16MMB1101	RK16MMB1101	RKL16MMB1101
200	200	RG20MMB1101	RGL20MMB1101	RK20MMB1101	RKL20MMB1101
	220	RG20MMB1401	RGL20MMB1401	RK20MMB1401	RKL20MMB1401
250	250	RG25MMB1401	RGL25MMB1401	RK25MMB1401	RKL25MMB1401
	280	RG25MMB1801	RGL25MMB1801	RK25MMB1801	RKL25MMB1801
320	320	RG32MMB1801	RGL32MMB1801	RK32MMB1801	RKL32MMB1801
	360	RG32MMB2201	RGL32MMB2201	RK32MMB2201	RKL32MMB2201

All dimensions are in millimetres unless otherwise stated.

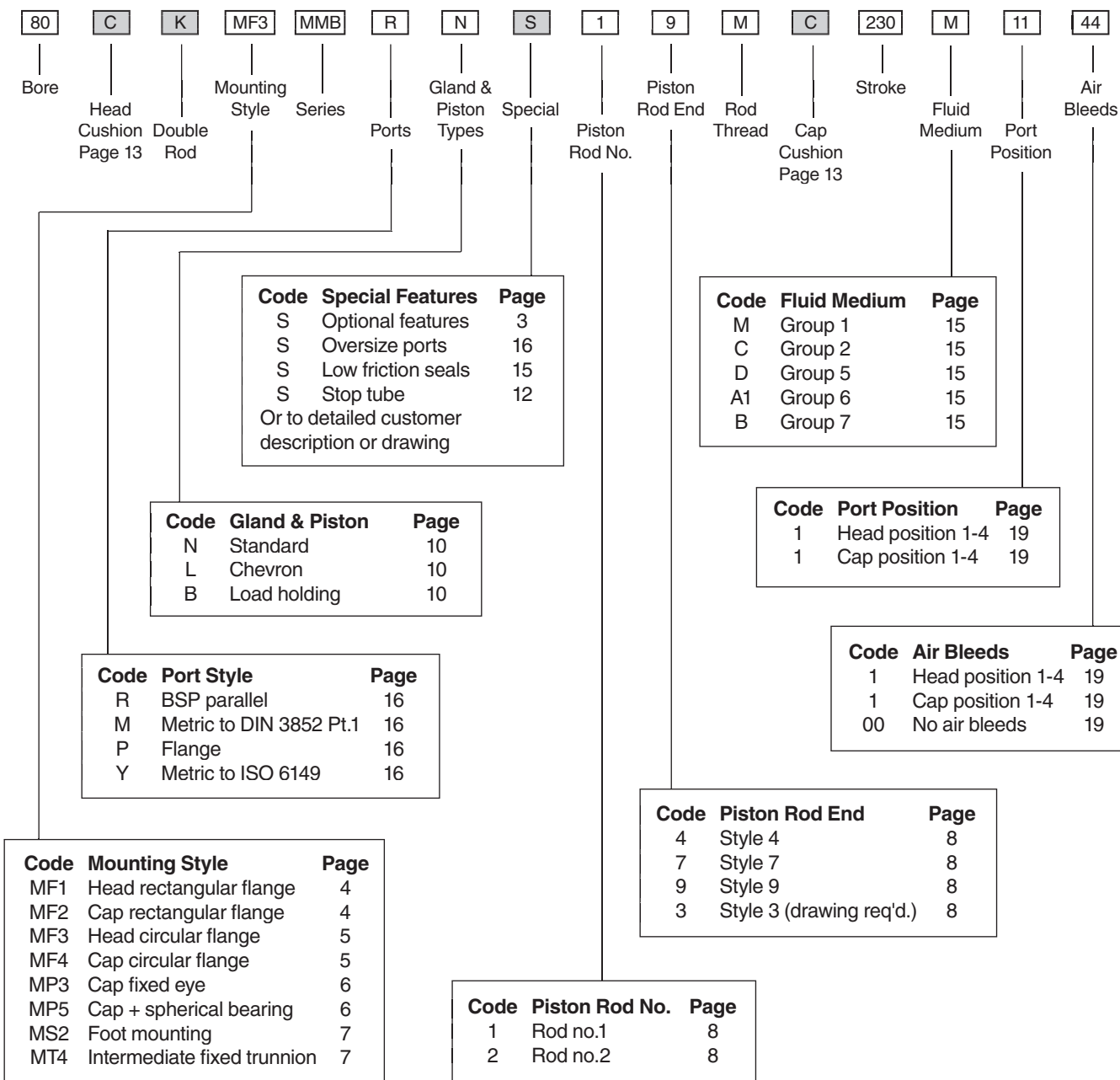

**Key**

Required for basic cylinder

Indicate optional features or leave blank

**Ports, Air Bleed and Cushion Adjusters**

Standard port location is position 1. Cushion adjustment needle valves, where specified, are at position 2.

**Double Rod Cylinders – Example**

100 K MF3 MMB R N 1 4 M 1 4 M 180 A1 11 44

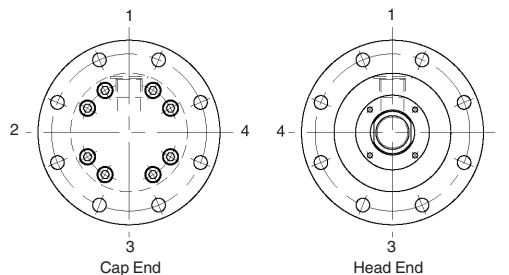

# Hydraulics Group

## Sales Offices

### Europe

**Austria**  
**Wiener Neustadt**  
Tel: +43 (0)2622 23501  
Fax: +43 (0)2622 66212

**Austria**  
**Wiener Neustadt**  
**(Resp. for Eastern Europe)**  
Tel: +43 (0)2622 23501-970  
Fax: +43 (0)2622 23501-977

**Belgium**  
**Nivelles**  
Tel: +32 (0)67 280 900  
Fax: +32 (0)67 280 999

**Czech Republic**  
**Klecany**  
Tel: +420 284 083 111  
Fax: +420 284 083 112

**Denmark**  
**Ballerup**  
Tel: +45 4356 0400  
Fax: +45 4373 3107

**Finland**  
**Vantaa**  
Tel: +358 20 753 2500  
Fax: +358 20 753 2200

**France**  
**Contamine-sur-Arve**  
Tel: +33 (0)450 25 80 25  
Fax: +33 (0)450 25 24 25

**Germany**  
**Kaarst**  
Tel: +49 (0)2131 4016 0  
Fax: +49 (0)2131 4016 9199

**Hungary**  
**Budapest**  
Tel: +36 (06)1 220 4155  
Fax: +36 (06)1 422 1525

**Ireland**  
**Dublin**  
Tel: +353 (0)1 293 9999  
Fax: +353 (0)1 293 9900

**Italy**  
**Corsico (MI)**  
Tel: +39 02 45 19 21  
Fax: +39 02 4 47 93 40

**The Netherlands**  
**Oldenzaal**  
Tel: +31 (0)541 585000  
Fax: +31 (0)541 585459

**Norway**  
**Ski**  
Tel: +47 64 91 10 00  
Fax: +47 64 91 10 90

**Poland**  
**Warsaw**  
Tel: +48 (0)22 573 24 00  
Fax: +48 (0)22 573 24 03

**Portugal**  
**Leca da Palmeira**  
Tel: +351 22 9997 360  
Fax: +351 22 9961 527

**Slovakia**  
**Ref. Czech Republic**

**Spain**  
**Madrid**  
Tel: +34 91 675 73 00  
Fax: +34 91 675 77 11

**Sweden**  
**Spånga**  
Tel: +46 (0)8 597 950 00  
Fax: +46 (0)8 597 951 10

**Turkey**  
**Merter/Istanbul**  
Tel.: +90 212 482 91 06 or 07  
Fax: +90 212 482 91 10

**United Kingdom**  
**Warwick**  
Tel: +44 (0)1926 317 878  
Fax: +44 (0)1926 317 855

### International

**Australia**  
**Castle Hill**  
Tel: +61 (0)2-9634 7777  
Fax: +61 (0)2-9899 6184

**Canada**  
**Milton, Ontario**  
Tel: +1 905-693-3000  
Fax: +1 905-876-0788

**China**  
**Beijing**  
Tel: +86 10 6561 0520  
Fax: +86 10 6561 0526

**Asia Pacific Group**  
**Hong Kong, Kowloon**  
Tel: +852 2428 8008  
Fax: +852 2425 6896

**India**  
**Mumbai**  
Tel: +91 22 5613 7081/82-85  
Fax: +91 22 2768 6841/6618

**Japan**  
**Tokyo**  
Tel: +(81) 3 6408 3900  
Fax: +(81) 3 5449 7201

**Latin America Group**  
**Brazil**  
Tel: +55 51 3470 9134  
Fax: +55 51 3470 9281

**South Africa**  
**Kempton Park**  
Tel: +27 (0)11-961 0700  
Fax: +27 (0)11-392 7213

**USA**  
**Cleveland (industrial)**  
Tel: +1 216-896-3000  
Fax: +1 216-896-4031  
**Lincolnshire (mobile)**  
Tel: +1 847-821-1500  
Fax: +1 847-821-7600

**Parker Hannifin is the world's premier supplier of motion and control systems and solutions, with sales and manufacturing facilities throughout the world.**  
**For product information and details of your nearest Parker sales office, visit us at [www.parker.com](http://www.parker.com) or call free on 00800 2727 5374.**



Catalogue HY07-1215/UK  
02/06 PC

© Copyright 2006  
Parker Hannifin Corporation  
All rights reserved.