



ГИДРОМОТОРС

(812) 400-69-69

www.gidro-motors.ru

HMI/HMD Hydraulic Cylinders

Metric tie rod cylinders for working pressures
up to 210 bar

aerospace
climate control
electromechanical
filtration
fluid & gas handling
hydraulics
pneumatics
process control
sealing & shielding



ENGINEERING YOUR SUCCESS.

Introduction

Introduction

The HMI and HMD ranges described in this catalogue are Compact Series cylinders to ISO 6020/2 and DIN 24 554, rated for use at working pressures up to 210 bar depending on the rod end and type of service. They have been designed to satisfy the requirements of a wide range of industries in which cylinders to ISO or DIN standards are specified.

In addition to the standard cylinders featured in this catalogue, HMI and HMD cylinders can be designed to suit customer requirements. Our engineers will be pleased to advise on unique designs to suit specific applications.

How to Use This Catalogue

Both the HMD range of cylinders, to DIN 24 554, and the more extensive HMI range of cylinders to ISO 6020/2 (1991), are described in this catalogue. All data applies to the HMI range; where information for the two ranges differs, HMD cylinder data is highlighted in yellow.

inPHorm and 3-D CAD

Parker offers easy-to-use software to simplify the cylinder selection process, saving your time and ensuring the accuracy of designs and drawings. InPHorm selection software and new 3-D CAD modelling software can be downloaded from our European Cylinder Division website. Please visit us at www.parker.com/eu or contact your local Sales Office for more information.

Contents

	Page
ISO and DIN Cylinder Range Comparison	3
Design Features and Benefits	4
Optional Features	6
Mounting Styles	7
Cylinder Dimensions	8
Double Rod Cylinders	12
Accessories	13
Mounting Information	16
Stroke Tolerances	17
Push and Pull Forces	17
Piston Rod Size Selection	18
Stop Tubes	19
Long Stroke Cylinders	19
Cushioning	20
Pressure Limitations	23
Ports	24
Piston Speeds	24
Seals & Fluids	25
Masses	25
Replacement Parts and Service	26
Repairs	27
Piston Rod End Data and Threads	28
How to Order Cylinders	29

Parker Offers the Widest Range of Industrial Cylinders

High Productivity – Low Cost of Ownership

Parker Hannifin's Cylinder Division is the world's largest supplier of hydraulic cylinders for industrial applications.

Parker manufactures a vast range of standard and special tie rod, roundline and 'mill' type cylinders to suit all types of industrial cylinder applications. Our cylinders are available to ISO, DIN, NFPA, ANSI and JIC standards, with other certifications available on request. All Parker hydraulic cylinders are

designed to deliver long, efficient service with low maintenance requirements, guaranteeing high productivity year after year.

About Parker Hannifin

Parker Hannifin is the global leader in motion and control technologies, partnering with its customers to increase their productivity and profitability. The company employs more than 57,000 people in 43 countries around the world, providing customers with technical excellence and first class customer service.

Visit us at www.parker.com/eu

Warning

FAILURE OR IMPROPER SELECTION OR IMPROPER USE OF THE PRODUCTS AND/OR SYSTEMS DESCRIBED HEREIN OR RELATED ITEMS CAN CAUSE DEATH, PERSONAL INJURY AND PROPERTY DAMAGE.

This document and other information from Parker Hannifin Corporation, its subsidiaries, sales offices and authorized distributors provide product or system options for further investigation by users having technical expertise. Before you select or use any product or system it is important that you analyse all aspects of your application and review the information concerning the product or system in the current product catalogue. Due to the variety of operating conditions and applications for these products or systems, the user, through his own analysis and testing, is solely responsible for making the final selection of the products and systems and assuring that all performance and safety requirements of the application are met.

The products described herein, including without limitation, product features, specifications, designs, availability and pricing, are subject to change by Parker Hannifin Corporation and its subsidiaries at any time without notice.

Offer of Sale

Please contact you local Parker representative for a detailed offer of sale.

ISO and DIN – a Comparison of Features

Parker's HMI and HMD metric cylinders meet the requirements of ISO 6020/2 (1991) and DIN 24 554, 160 Bar Compact Series.

All the cylinders illustrated below satisfy the ISO standard; the five mounting styles highlighted in yellow also meet DIN 24 554. ISO and DIN versions of these five cylinders are interchangeable, differing only in the design of the Style JJ mounting flange.

ISO 6020/2 Cylinder Range

- 12 standard mounting styles
- Up to 3 rod sizes per bore
- Up to 3 male and 3 female rod end threads per bore
- Wider range of mounting and rod end accessories
- Wider range of special features

DIN 24 554 Cylinder Range

- 5 mounting styles
- 2 rod sizes per bore size
- 1 male rod end thread per bore size

ISO and DIN Ranges

- Working pressure up to 210 bar
- Bore sizes – 25mm to 200mm
- Piston rod diameters – 12mm to 140mm
- Single and double rod designs available
- Strokes – available in any practical stroke length
- Cushions – available at either or both ends
- Fluids and seals – five seal types to suit a wide range of fluid specifications
- Temperature ranges – -20°C to +150°C depending on fluid and seal types

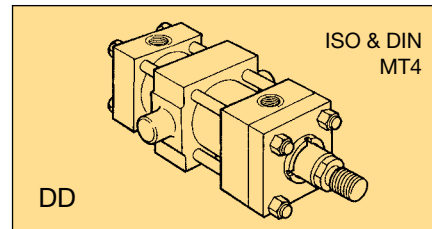
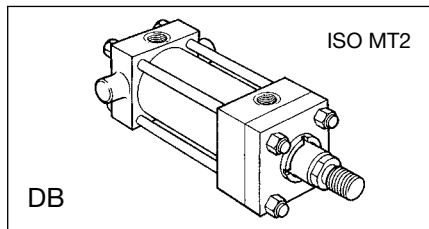
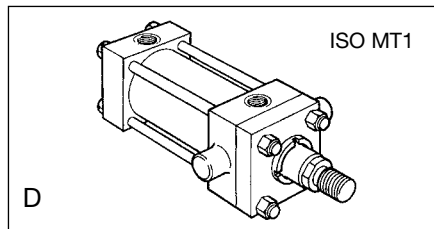
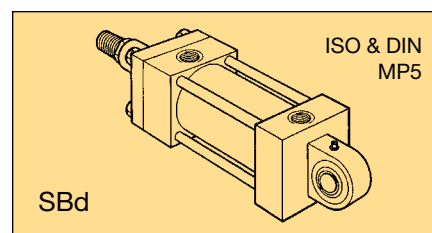
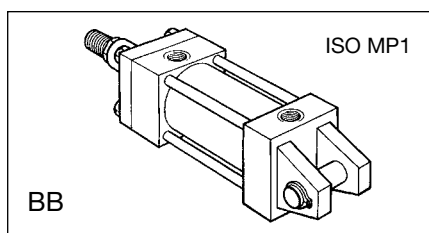
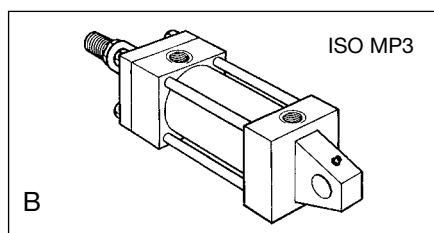
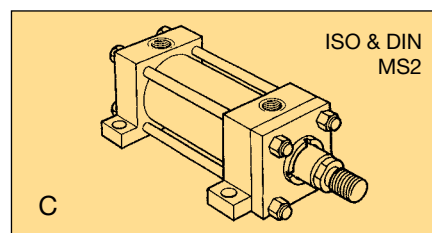
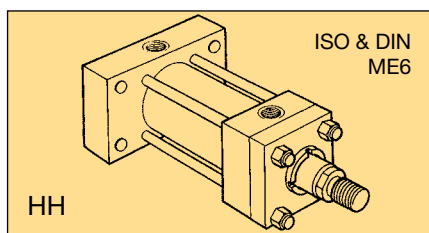
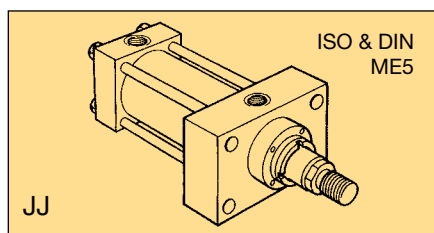
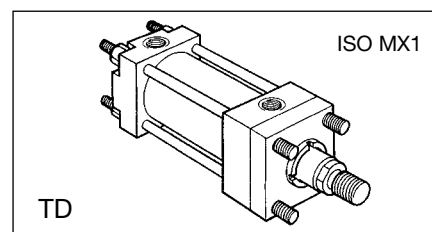
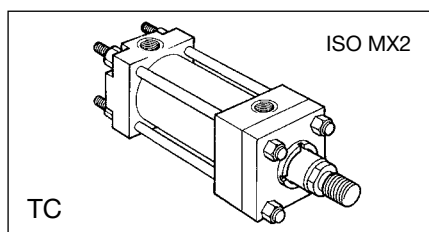
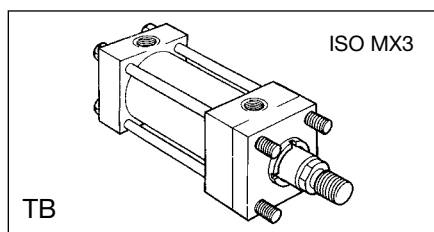

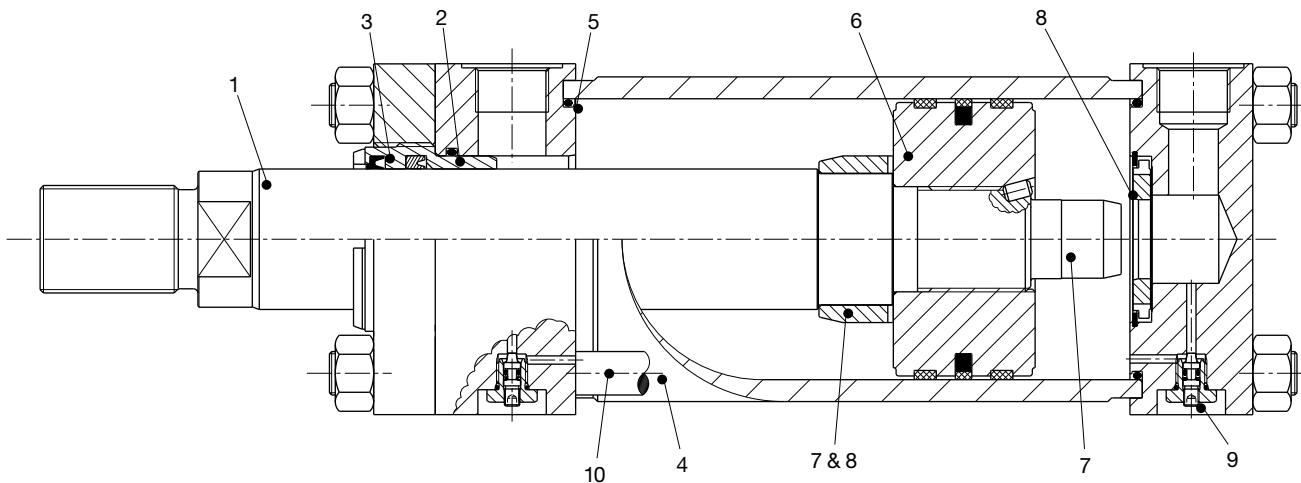

1 Piston Rod

Gland seal life is maximised by manufacturing piston rods from precision ground, high tensile carbon alloy steel, hard chrome plated and polished to 0.2µm max. Piston rods are induction case hardened to Rockwell C54 minimum before chrome plating, resulting in a dent-resistant surface.

2 Parker's Detachable Rod Gland

Continuous lubrication, and therefore longer gland life, are provided by the long bearing surface inboard of the lipseal. The gland, complete with rod seals, can easily be removed without dismantling the cylinder, so servicing is quicker – and therefore more economical.

3 Rod Seals

Efficient sealing under all operating conditions is achieved by using a serrated lipseal with a series of sealing edges which increase the sealing effect as pressure increases. On the return stroke these serrations act as a check valve, allowing the oil adhering to the rod to pass back into the cylinder.

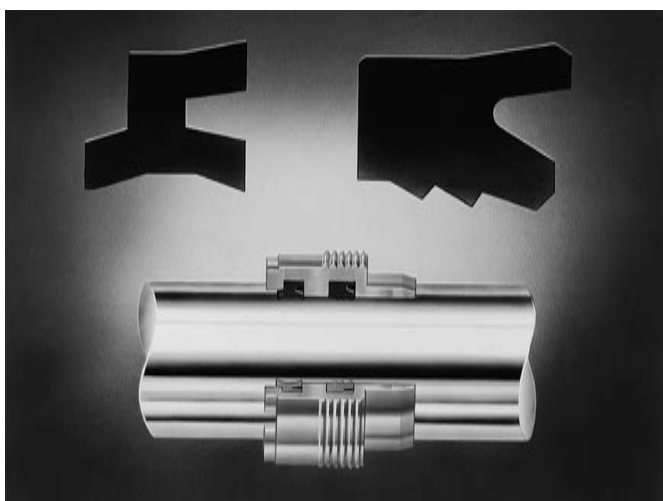

The double lip wiperseal acts as a secondary seal, trapping excess lubricating film in the chamber between the wiper and lip seals. Its outer lip prevents the ingress of dirt into the cylinder, extending the life of gland and seals.

Standard lipseals are manufactured from an enhanced polyurethane, giving efficient retention of pressurized fluid and a service life of up to five times that of traditional seal materials. Standard rod seals are suitable for speeds of up to 0.5m/s – special seals are available for higher speed applications.

4 Cylinder Body

Strict quality control standards and precision manufacture ensure that all tubes meet strict standards of straightness, roundness and surface finish. The steel tubing is surface finished to minimise internal friction and prolong seal life.

5 Cylinder Body Seals

To make sure that the cylinder body remains leaktight, even under pressure shock conditions, Parker fits pressure-energised body seals.

6 One-Piece Piston

Side loading is resisted by the wear rings on the piston. A long thread engagement secures the piston to the piston rod and, as an added safety feature, pistons are secured by both a thread-locking compound and a locking pin. Three standard seal combinations are available to suit different applications – see 'Piston Seals' opposite.

7 Cushioning

Cushioning reduces noise and shock loading, resulting in faster cycle times and higher productivity. Progressive deceleration is available by selecting profiled cushions at the head and cap – see page 20 for details. The head end cushion is self-centring, while the polished cap end spear is an integral part of the piston rod.

8 Floating Cushion Bushes & Sleeves

Closer tolerances – and therefore more effective cushioning – are permitted by the use of a floating cushion sleeve at the head end of the cylinder, and a floating cushion bush at the cap end. A specially designed cushion sleeve on bore sizes up to 100mm operates as a check valve. On larger bore sizes a conventional ball check valve is used. The use of a check valve in the head and lifting of the bronze cushion bush in the cap, provides minimal fluid restriction to the start of the return stroke. This allows full pressure to be applied over the whole area of the piston, to provide full power and fast cycle times.

9 Cushion Adjustment

Needle valves are provided at both ends of the cylinder for precise cushion adjustment, and retained within the head and cap so that they cannot be inadvertently removed. The cartridge type needle valve illustrated below is fitted to cylinders of up to 125mm bore – for location, see page 24.

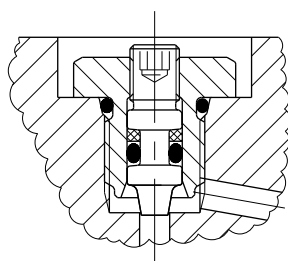

10 Tie Rod Construction

Tie rod construction, with tie rods torque-loaded on assembly, imposes a compressive force on the cylinder tube which counters the tensile forces generated by system pressure. The result – a fatigue-free cylinder with long service life and exceptionally compact dimensions.

Special Designs

Parker's design and engineering staff are available to produce special designs to meet customer's specific requirements. Alternative sealing arrangements, special mounting styles, different bores and rod sizes are just a few of the custom features which can be supplied.

Piston Seals

A variety of piston seal options are available, to suit different applications.

Standard Pistons are suitable for holding a load in position, as the piston seals are leak-tight under normal operating conditions. Wear rings prevent metal-to-metal contact. Standard piston seals are suitable for piston speeds up to 1m/s.

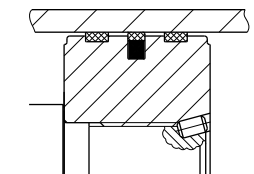

LoadMaster Pistons employ extra heavy duty wear rings to resist side loading and are recommended for long stroke cylinders, especially when pivot mounted.

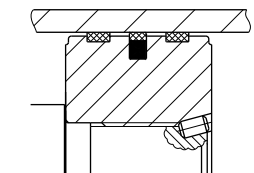

Servo Cylinders

Servo cylinders permit fine control of acceleration, velocity and position in applications where very low friction and an absence of stick-slip are required. They may be used in conjunction with integral or external transducers.

Low Friction Pistons employ a PTFE seal and PTFE wear rings, and may be used for piston speeds up to 1m/s. They are not suitable for supporting loads in a fixed position.

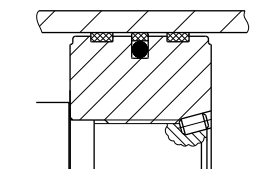

Low Friction Gland Seals comprise two low friction PTFE stepped seals and a conventional double lip wiper seal – see page 25.

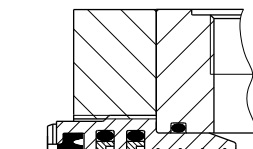

Air Bleeds

The option of bleed screws is available at either or both ends of the cylinder, at any position except in the port face. To ensure operator safety, the standard air bleed (illustrated) is recessed into the head and cap and retained so that it cannot be inadvertently removed. On cylinders of 50mm bore and above, where it is essential to have the air bleed in the port face, please consult the factory. The option of an ATE-type protruding air bleed is also available for applications where a hose connection is required – please consult the factory for details.

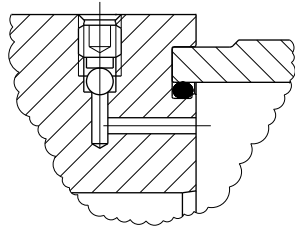

Gland Drains

The accumulation of fluid between the gland seals of long stroke cylinders, cylinders with constant back pressure or where the ratio of the extend speed to the retract speed is greater than 2 to 1, can be relieved by specifying an optional gland drain. A transparent tube fitted between the gland drain and the reservoir allows fluid loss from concealed or inaccessible cylinders to be monitored, giving an early indication of the need for gland servicing.

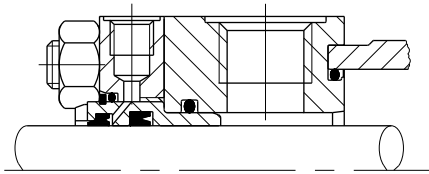

A 1/8 BSPP gland drain can be provided in the retainer on all mounting styles, except as follows.

- Style JJ, 25 to 80mm bores, and style D, 100 to 200mm bores, where it is mounted in the head.
- Where the gland drain is provided in the retainer, the thickness of the retainer is increased by 6mm on 32 and 40mm bore cylinders with no.2 rod, and by 4mm on 63mm bore cylinders with no.2 rod.
- On style JJ cylinders, gland drains cannot normally be positioned in the same face as ports or cushion valves – if required, please consult the factory.

Stroke Limiters

Where absolute precision in stroke length is required, a screwed adjustable stop can be supplied. Several types are available – please contact the factory, specifying details of the application and the adjustment required.

Rod Locking Devices

These units provide positive locking of the piston rod. Of fail-safe design, they require hydraulic pressure to release while loss of pressure causes the clamp to operate. Please contact the factory for further information.

Rod End Wrench Flats

While standard rod ends are supplied with two wrench flats, the option of four flats is also available, to ease access in confined spaces. See rod end codes 1, 2 and 5 in the ordering code on page 29. Note that the larger rod shoulder area of the two flat design offers greater resistance to fatigue in certain push load applications – see Pressure Limitations on page 23.

Single-Acting Cylinders

Standard HMI and HMD series cylinders are of the double-acting type. They are suitable for use as single-acting cylinders, where the load or other external force is used to return the piston after the pressure stroke.

Spring-Returned, Single-Acting Cylinders

Single-acting cylinders can also be supplied with an internal spring to return the piston after the pressure stroke. Please supply details of load conditions and friction factors, and advise whether the spring is required to advance or return the piston rod.

On spring-returned cylinders, it is recommended that tie rod extensions be specified to allow the spring to be 'backed off' until compression is relieved. Please contact the factory when ordering spring-returned cylinders.

Multiple Stroke Positioning

To obtain linear force in one plane with controlled stopping at intermediate points, several designs are available. Three stopped positions can be achieved by mounting two standard single rod style HH cylinders back-to-back, or by using through-tie rods. By extending or retracting the stroke of each cylinder independently, it is possible to achieve three positions at the piston ends. An alternative technique is to use a tandem cylinder with an independent piston rod in the cap section. Please consult the factory for further details.

Rod End Bellows

Unprotected piston rod surfaces which are exposed to contaminants should be protected by rod end bellows. Longer rod extensions are required to accommodate the collapsed length of the bellows. Please consult the factory for further information.

Metallic Rod Wipers

Metallic rod wipers replace the standard wiper seal, and are recommended where dust or splashing might damage the wiper seal material. Metallic rod wipers do not affect the overall dimensions of cylinders of 50mm bore and above – where the overall dimensions of smaller bore cylinders are critical, please consult the factory.

Position Sensors

These can be fitted to give reliable end of stroke or mid-stroke signals. Please contact the factory for details.

Position Feedback

Linear position transducers of various types are available for HMI and HMD series cylinders. Please contact the factory for details.

All dimensions are in millimetres unless otherwise stated.

Mounting Styles

Mounting Styles and Where to Use Them

See also application-specific mounting information on page 16.

Extended Tie Rod Mountings – Styles TB, TC and TD

Application

- straight line force transfer
- compression (push) – use cap end mountings TC or TD
- tension (pull) – use head end mountings TB or TD

Benefits

- ease of mounting where space is limited
- high efficiency – force is absorbed on cylinder's centre line
- TD double-ended mounting allows brackets or switches to be attached to cylinder

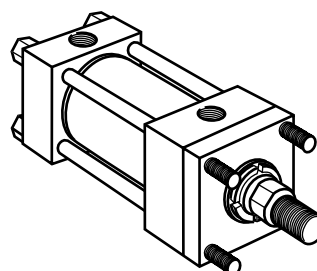

TB

Flange Mountings – Styles HH and JJ

Application

- straight line force transfer
- compression (push) – use cap end mounting HH
- tension (pull) – use head end mounting JJ

Benefits

- exceptionally rigid mounting due to large flange area
- high efficiency – force is absorbed on cylinder's centre line

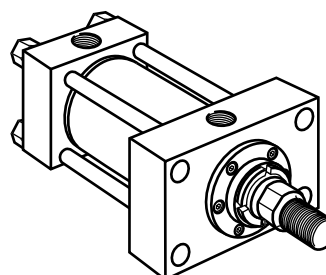

JJ (ISO version)

Foot Mounting – Style C

Application

- straight line force transfer
- suitable for push or pull applications
- force is **not** absorbed on centre line – secure attachment, eg: a thrust key (page 16) and effective load guidance are vital

Benefits

- ease of mounting and adjustment

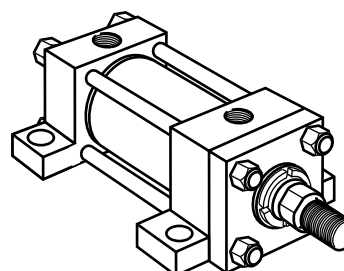

C

Pivot Mountings – Styles B, BB and SBd

Application

- curved path force transfer
- movement in a single plane – use fixed clevis styles B or BB
- movement in more than one plane – use spherical bearing style SBd

Benefits

- ease of attachment – use with plain or spherical bearing at rod end
- greater flexibility for the machine designer
- self-alignment resists wear of cylinder's bearing surfaces

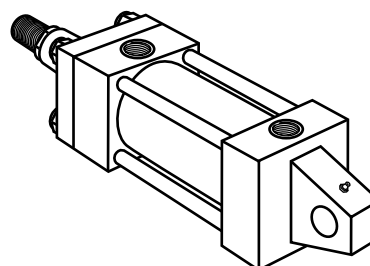

B

Trunnion Mountings – Styles D, DB and DD

Application

- curved path force transfer
- movement in a single plane
- compression (push) – use DB or DD mountings
- tension (pull) – use D or DD mountings

Benefits

- greater flexibility for the machine designer
- self-alignment resists wear of cylinder's bearing surfaces
- high efficiency – force is absorbed on cylinder's centre line
- ease of attachment – use with pivot mounting at rod end

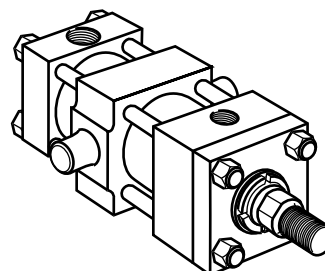

DD

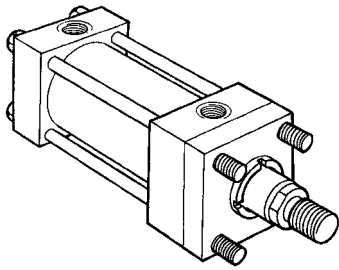

Style TB
Tie Rods Extended Head End
ISO Style MX3

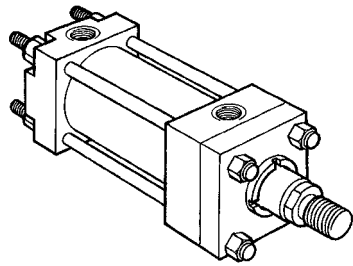
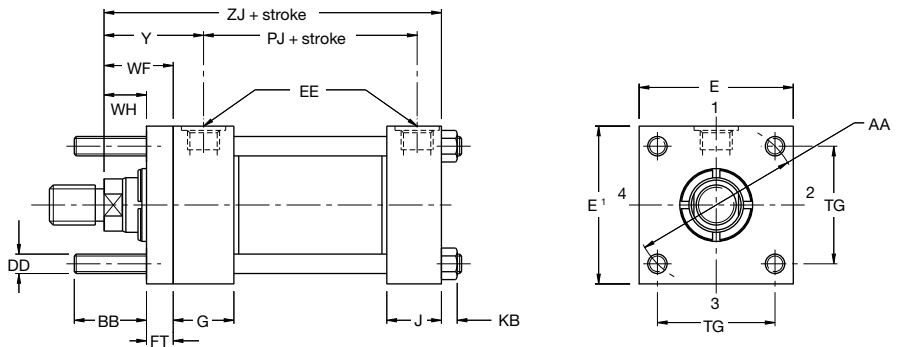

Style TC
Tie Rods Extended Cap End
ISO Style MX2

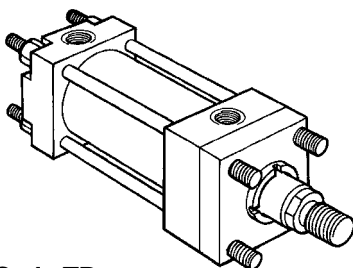
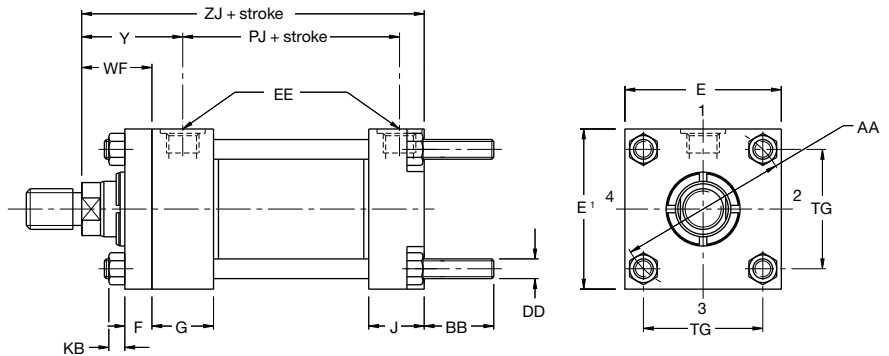

Style TD
Tie Rods Extended Both Ends
ISO Style MX1

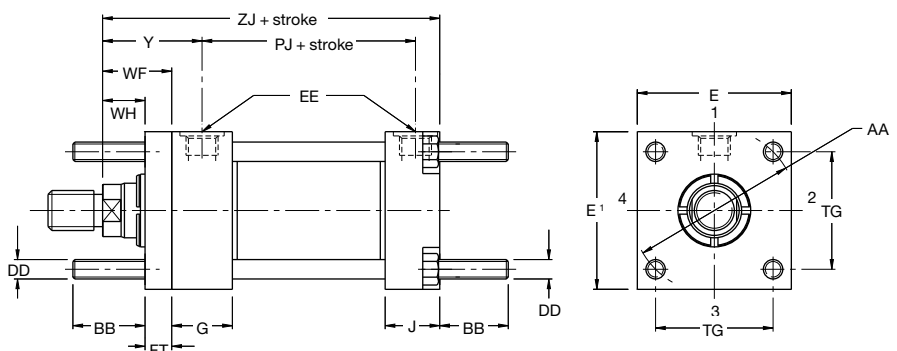

¹ Head depth E increased by 5mm in port face to accommodate port on 25 and 32mm bore cylinders

Dimensions – TB, TC & TD See Rod End Dimensions, page 28 & Mounting Information, page 16

Bore Ø	AA	BB	DD	E	EE (BSPP) inches	F max	FT	G	J	KB	TG	WF	WH	Y	+ Stroke	
															PJ	ZJ
25	40	19	M5x0.8	40 ¹	G ¹ / ₄	10	10	40	25	4	28.3	25	15	50	53	114
32	47	24	M6x1	45 ¹	G ¹ / ₄	10	10	40	25	5	33.2	35	25	60	56	128
40	59	35	M8x1	64	G ³ / ₈	10	10	45	38	6.5	41.7	35	25	62	73	153
50	74	46	M12x1.25	76	G ¹ / ₂	16	16	45	38	10	52.3	41	25	67	74	159
63	91	46	M12x1.25	90	G ¹ / ₂	16	16	45	38	10	64.3	48	32	71	80	168
80	117	59	M16x1.5	115	G ³ / ₄	20	20	50	45	13	82.7	51	31	77	93	190
100	137	59	M16x1.5	130	G ³ / ₄	22	22	50	45	13	96.9	57	35	82	101	203
125	178	81	M22x1.5	165	G1	22	22	58	58	18	125.9	57	35	86	117	232
160	219	92	M27x2	205	G1	25	25	58	58	22	154.9	57	32	86	130	245
200	269	115	M30x2	245	G1 ¹ / ₄	25	25	76	76	24	190.2	57	32	98	165	299

All dimensions are in millimetres unless otherwise stated.

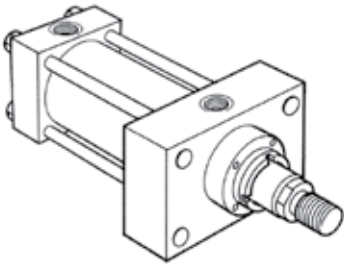

Style JJ
Head Rectangular Flange

ISO Style ME5 DIN Style ME5

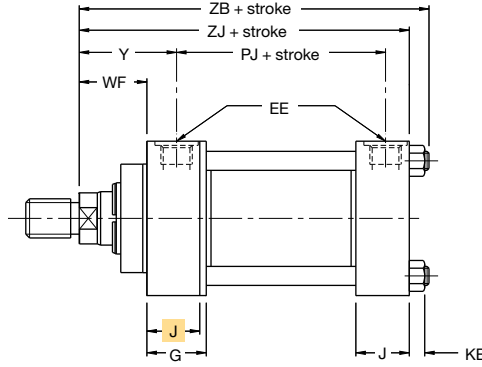

Note: a one-piece head is fitted to 25-40mm bore cylinders.

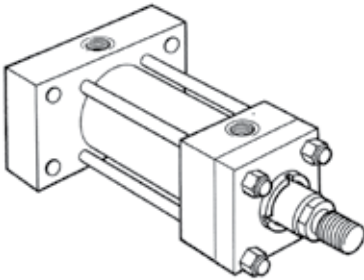
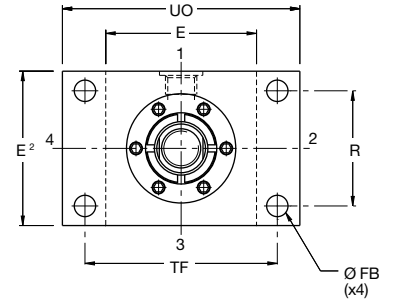

Style HH
Cap Rectangular Flange

ISO Style ME6 DIN Style ME6

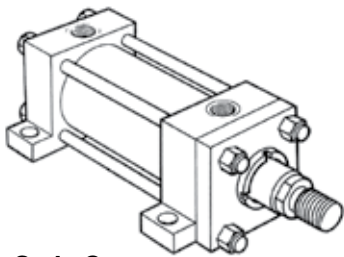
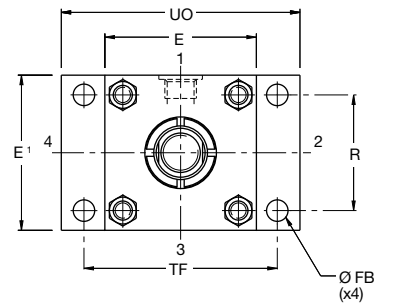
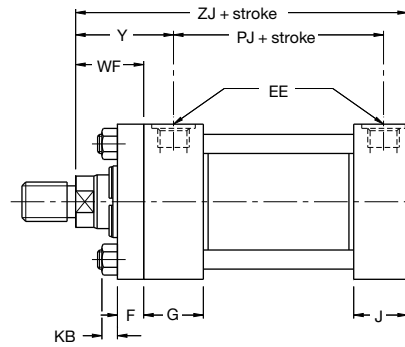

Style C
Side Lugs

ISO Style MS2 DIN Style MS2

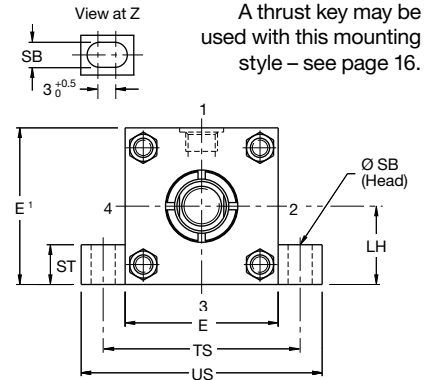
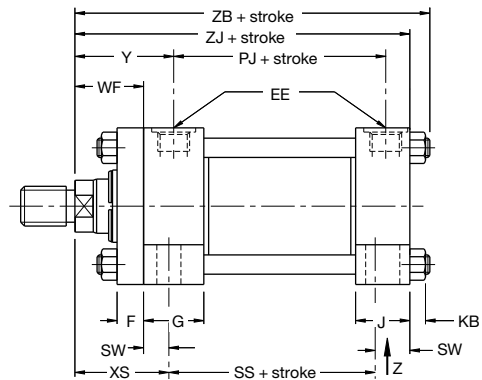

A thrust key may be used with this mounting style – see page 16.

¹ Head depth E increased by 5mm in port face to accommodate port on 25 and 32mm bore cylinders

² On 25 and 32mm bore JJ mount cylinders with port in position 2 or 4, head depth E is increased by 5mm in position 1

Dimensions – JJ, HH & C See Rod End Dimensions, page 28 & Mounting Information, page 16

Bore Ø	E	EE (BSPP) inches	F max	FB	G	J	KB	LH h10	R	SB	ST	SW	TF	TS	UO	US	WF	XS	Y	+ Stroke			
																				PJ	SS	ZB max	ZJ
25	40 ¹	G1/4	10	5.5	40	25	4	19	27	6.6	8.5	8	51	54	65	72	25	33	50	53	72	121	114
32	45 ¹	G1/4	10	6.6	40	25	5	22	33	9	12.5	10	58	63	70	84	35	45	60	56	72	137	128
40	64	G3/8	10	11	45	38	6.5	31	41	11	12.5	10	87	83	110	103	35	45	62	73	97	166	153
50	76	G1/2	16	14	45	38	10	37	52	14	19	13	105	102	130	127	41	54	67	74	91	176	159
63	90	G1/2	16	14	45	38	10	44	65	18	26	17	117	124	145	161	48	65	71	80	85	185	168
80	115	G3/4	20	18	50	45	13	57	83	18	26	17	149	149	180	186	51	68	77	93	104	212	190
100	130	G3/4	22	18	50	45	13	63	97	26	32	22	162	172	200	216	57	79	82	101	101	225	203
125	165	G1	22	22	58	58	18	82	126	26	32	22	208	210	250	254	57	79	86	117	130	260	232
160	205	G1	25	26	58	58	22	101	155	33	38	29	253	260	300	318	57	86	86	130	129	279	245
200	245	G1 1/4	25	33	76	76	24	122	190	39	44	35	300	311	360	381	57	92	98	165	171	336	299

All dimensions are in millimetres unless otherwise stated.

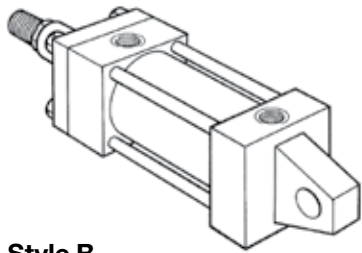

Style B
Cap Fixed Eye
ISO Style MP3

Pivot pin not supplied

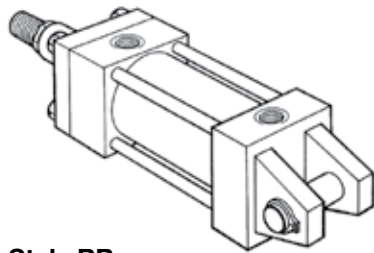
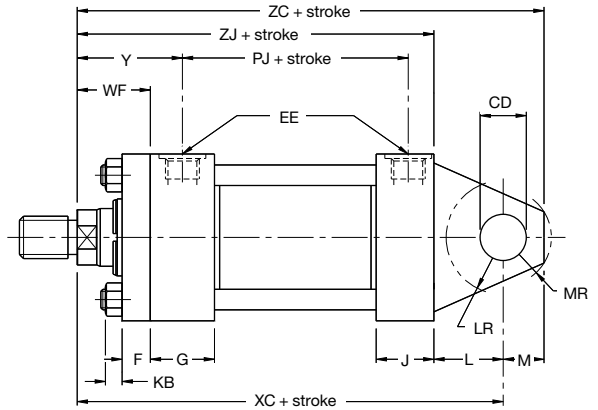
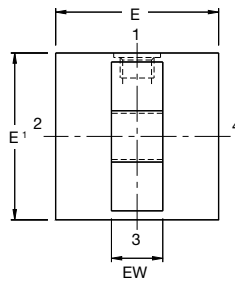

Style BB
Cap Fixed Clevis
ISO Style MP1

Supplied complete with pivot pin

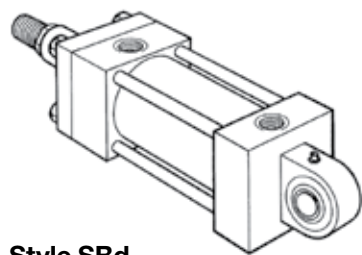
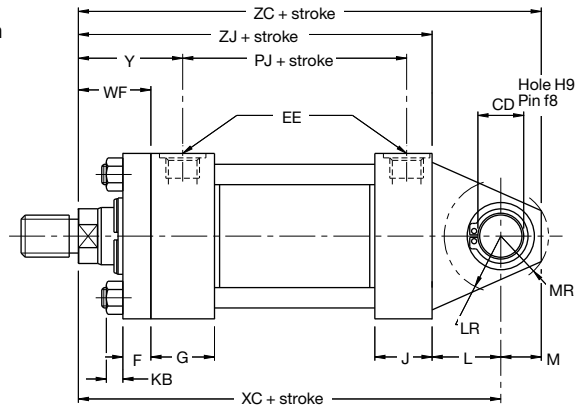
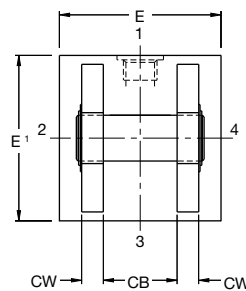

Style SBd
Cap Fixed Eye
with Spherical Bearing
ISO Style MP5 **DIN Style MP5**

Pivot pin not supplied

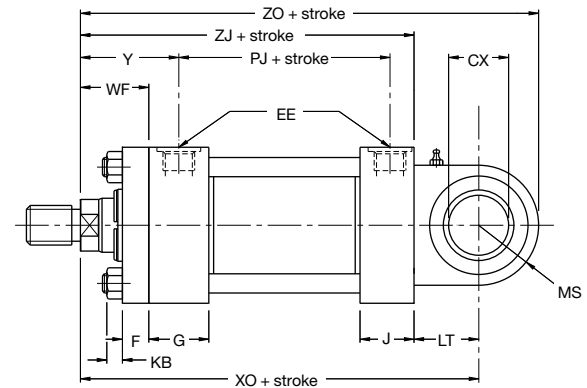
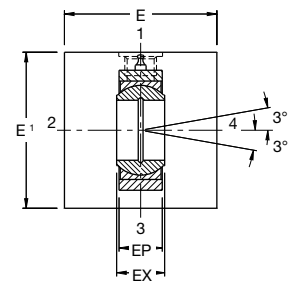

¹ Head depth E increased by 5mm in port face to accommodate port on 25 and 32mm bore cylinders

Dimensions – B, BB & SBd See Rod End Dimensions, page 28 & Mounting Information, page 16

Bore Ø	CB A16	CD H9	CW	CX	E	EE (BSPP) inches	EP	EW h14	EX	F max	G	J	KB	L	LR	LT	M	MR	MS max	WF	Y	+ Stroke					
																						PJ	XC	XO	ZC	ZJ	ZO
25	12	10	6	12 ^{-0.008}	40 ¹	G ¹ / ₄	8	12	10	10	40	25	4	13	12	16	10	12	20	25	50	53	127	130	137	114	150
32	16	12	8	16 ^{-0.008}	45 ¹	G ¹ / ₄	11	16	14	10	40	25	5	19	17	20	12	15	22.5	35	60	56	147	148	159	128	170.5
40	20	14	10	20 ^{-0.012}	64	G ³ / ₈	13	20	16	10	45	38	6.5	19	17	25	14	16	29	35	62	73	172	178	186	153	207
50	30	20	15	25 ^{-0.012}	76	G ¹ / ₂	17	30	20	16	45	38	10	32	29	31	20	25	33	41	67	74	191	190	211	159	223
63	30	20	15	30 ^{-0.012}	90	G ¹ / ₂	19	30	22	16	45	38	10	32	29	38	20	25	40	48	71	80	200	206	220	168	246
80	40	28	20	40 ^{-0.012}	115	G ³ / ₄	23	40	28	20	50	45	13	39	34	48	28	34	50	51	77	93	229	238	257	190	288
100	50	36	25	50 ^{-0.012}	130	G ³ / ₄	30	50	35	22	50	45	13	54	50	58	36	44	62	57	82	101	257	261	293	203	323
125	60	45	30	60 ^{-0.015}	165	G1	38	60	44	22	58	58	18	57	53	72	45	53	80	57	86	117	289	304	334	232	384
160	70	56	35	80 ^{-0.015}	205	G1	47	70	55	25	58	58	22	63	59	92	59	59	100	57	86	130	308	337	367	245	437
200	80	70	40	100 ^{-0.020}	245	G ¹ / ₄	57	80	70	25	76	76	24	82	78	116	70	76	120	57	98	165	381	415	451	299	535

All dimensions are in millimetres unless otherwise stated.

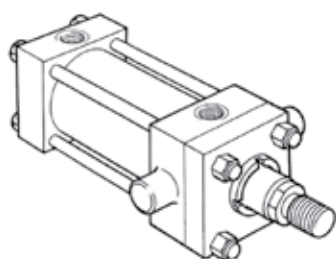

Style D
 Head Trunnion
 ISO Style MT1

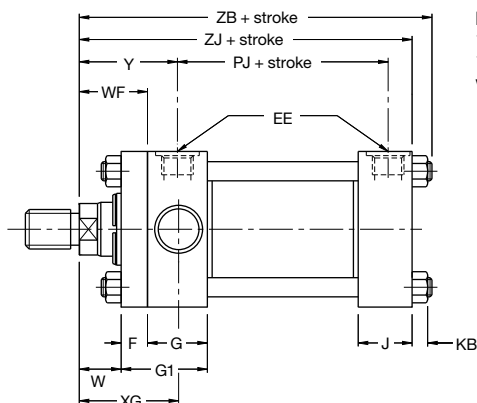

Note: A one-piece head and retainer is used on 100mm – 200mm bore sizes – G1 dimension. On 160 and 200mm bores, the bolted gland is recessed, with tie rods screwed into the head.

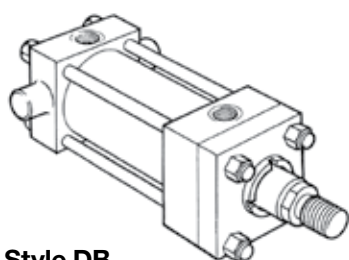
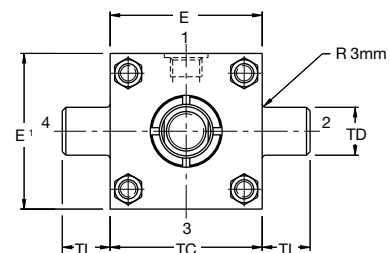

Style DB
 Cap Trunnion
 ISO Style MT2

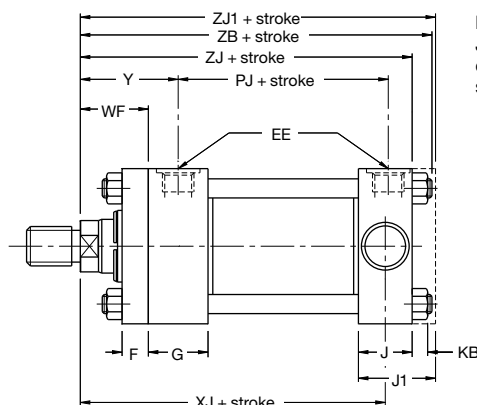

Note: On 80 – 200mm bore cylinders, dimension J becomes J1. On 100 – 200mm bore cylinders, dimension ZJ1 replaces ZB, and tie rods are screwed directly into the cap.

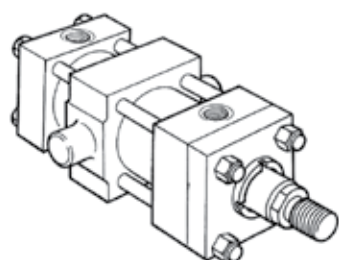
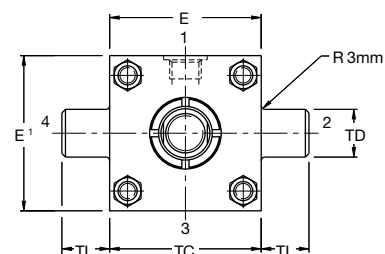

Style DD
 Intermediate Fixed Trunnion
 ISO Style MT4 DIN Style MT4

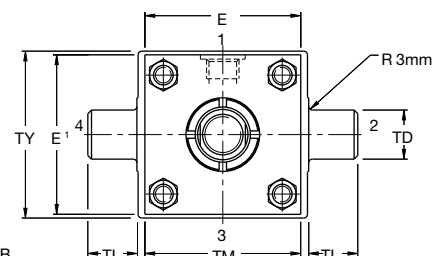
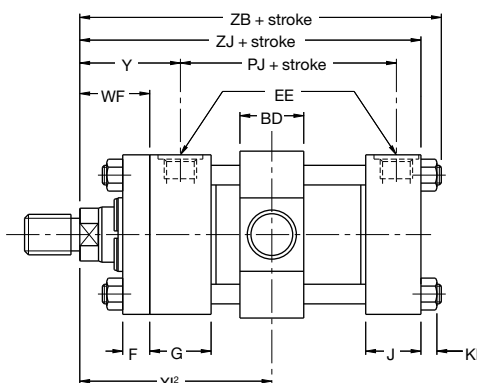

¹ Head depth E increased by 5mm in port face to accommodate port on 25 and 32mm bore cylinders

² Dimension to be specified by customer

Dimensions – D, DB & DD See Rod End Dimensions, page 28 & Mounting Information, page 16

Bore Ø	BD	E	EE (BSPP) inches	F max	G	G1	J	J1	KB	TC	TD f8	TL	TM	TY	W	WF	XG	Y	+ Stroke				Style DD min stroke	Min XI dim'n ²	
																			PJ	XJ	ZJ	ZJ1			ZB max
25	20	40 ¹	G ¹ / ₄	10	40	-	25	-	4	38	12	10	48	45	-	25	44	50	53	101	114	-	121	10	78
32	25	45 ¹	G ¹ / ₄	10	40	-	25	-	5	44	16	12	55	54	-	35	54	60	56	115	128	-	137	10	90
40	30	64	G ³ / ₈	10	45	-	38	-	6.5	63	20	16	76	76	-	35	57	62	73	134	153	-	166	15	97
50	40	76	G ¹ / ₂	16	45	-	38	-	10	76	25	20	89	89	-	41	64	67	74	140	159	-	176	15	107
63	40	90	G ¹ / ₂	16	45	-	38	-	10	89	32	25	100	95	-	48	70	71	80	149	168	-	185	15	114
80	50	115	G ³ / ₄	20	50	-	45	50	13	114	40	32	127	127	-	51	76	77	93	168	190	194	212	20	127
100	60	130	G ³ / ₄	22	50	72	45	58	13	127	50	40	140	140	35	57	71	82	101	187	203	216	225	20	138
125	73	165	G1	22	58	80	58	71	18	165	63	50	178	178	35	57	75	86	117	209	232	245	260	25	153
160	90	205	G1	25	58	88	58	88	22	203	80	63	215	216	32	57	75	86	130	230	245	275	279	30	161
200	110	245	G ¹ / ₄	25	76	108	76	108	24	241	100	80	279	280	32	57	85	98	165	276	299	330	336	30	190

All dimensions are in millimetres unless otherwise stated.

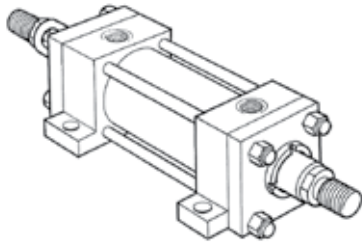

Double Rod Cylinder

Available with Styles TB, TD, JJ, C, D, DD (Style C Illustrated)

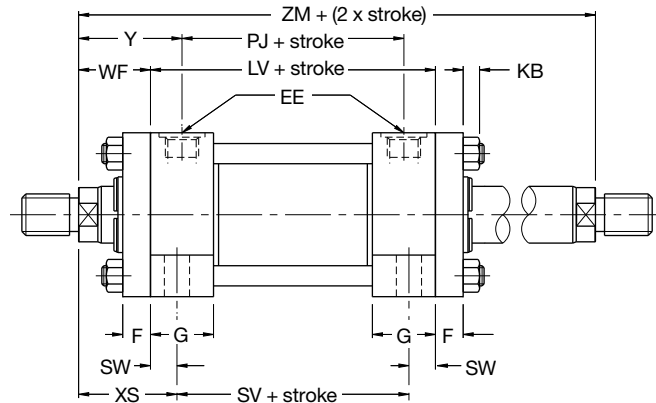

Double Rod Cylinders

Mounting Styles and Codes

Double rod cylinders are denoted by a 'K' in the cylinder model code, shown on page 29.

DIN Cylinder Range

HMD double rod cylinders are only available with mounting styles JJ, C and DD and rod numbers 1 and 2. These cylinders do not conform to DIN 24 554.

Dimensions

To obtain dimensional information for double rod cylinders, first select the desired mounting style by referring to the corresponding single rod models shown on pages 8 to 11. These should be supplemented with dimensions from the table opposite to provide a full set of dimensions.

Rod Strength

Double rod cylinders employ two separate piston rods, with one screwed into the end of the other within the piston assembly. As a result, one piston rod is stronger than the other. The stronger rod can be identified by the letter 'K' stamped on its end. Different maximum pressure ratings apply to the stronger and weaker rods of a double rod cylinder – see Pressure Limitations, page 23.

Minimum Stroke Length – Female Rod Ends (HMI only)

Where a female (code 5 or 9) piston rod end is required on a double rod cylinder with a stroke of 80mm or less, and a bore of 80mm or above, please consult the factory.

Bore Ø	Rod No.	MM Rod Ø	Add Stroke			Add 2 x Stroke
			LV	PJ	SV	ZM
25	1	12	104	53	88	154
	2	18				
32	1	14	108	56	88	178
	2	22				
40	1	18	125	73	105	195
	2	28				
50	1	22	125	74	99	207
	2	36				
	3	28				
63	1	28	127	80	93	223
	2	45				
	3	36				
80	1	36	144	93	110	246
	2	56				
	3	45				
100	1	45	151	101	107	265
	2	70				
	3	56				
125	1	56	175	117	131	289
	2	90				
	3	70				
160	1	70	188	130	130	302
	2	110				
	3	90				
200	1	90	242	160	172	356
	2	140				
	3	110				

All dimensions are in millimetres unless otherwise stated.

Accessory Selection

Accessories for the rod end of a cylinder are selected by reference to the rod end thread, shown on page 28, while the same accessories, when used at the cap end, are selected by cylinder bore size.

Accessories fitted to the rod end have the same pin diameters as those used at the cylinder cap end when supplied for a No.1 rod, or for No.2 or No.3 rods with code 2 or 7 rod end styles.

Rod and Cap End Accessories

Rod End, HMI range

- rod clevis (1), eye bracket (2) and pivot pin (3)
- plain rod eye (4), clevis bracket (5) and pivot pin (3)

Rod End, HMI and HMD ranges

- rod eye with spherical bearing (6), mounting bracket/pivot pin assembly (7)

Cap End, HMI range

- eye bracket for style BB mounting (2)
- clevis bracket for style B mounting (5)
- pivot pin for clevis bracket (3)

Cap end, HMI and HMD ranges

- mounting bracket/pivot pin assembly style SBd mounting (7)

Rod Clevis, Eye Bracket and Pivot Pin

Thread KK	Rod Clevis (1)	Eye Bracket (2)	Pivot Pin (3)	Nominal Force kN	Mass kg
M10x1.25	143447	144808	143477	10.3	0.3
M12x1.25	143448	144809	143478	16.9	0.6
M14x1.5	143449	144810	143479	26.4	0.8
M16x1.5	143450	144811	143480	41.2	2.2
M20x1.5	143451	144812	143480	65.5	2.7
M27x2	143452	144813	143481	106	5.9
M33x2	143453	144814	143482	165	9.2
M42x2	143454	144815	143483	258	18
M48x2	143455	144816	143484	422	27
M64x3	143456	144817	143485	660	39

Pivot Pin (3) Dimensions

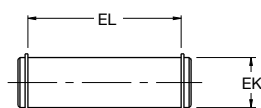

Part No.	EK f8	EL	Mass kg
143477	10	29	0.02
143478	12	37	0.05
143479	14	45	0.08
143480	20	66	0.2
143481	28	87	0.4
143482	36	107	1.0
143483	45	129	1.8
143484	56	149	4.2
143485	70	169	6.0

Rod Clevis (1) Dimensions

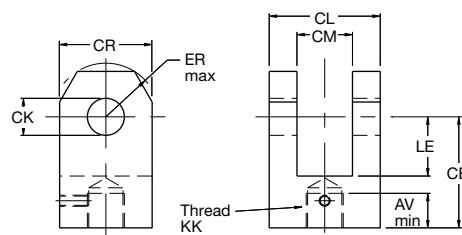

Part No.	AV	CE	CK H9	CL	CM A16	CR	ER	KK	LE min	Mass kg
143447	14	32	10	25	12	20	12	M10x1.25	13	0.08
143448	16	36	12	32	16	32	17	M12x1.25	19	0.25
143449	18	38	14	40	20	30	17	M14x1.5	19	0.32
143450	22	54	20	60	30	50	29	M16x1.5	32	1.0
143451	28	60	20	60	30	50	29	M20x1.5	32	1.1
143452	36	75	28	83	40	60	34	M27x2	39	2.3
143453	45	99	36	103	50	80	50	M33x2	54	2.6
143454	56	113	45	123	60	102	53	M42x2	57	5.7
143455	63	126	56	143	70	112	59	M48x2	63	7.8
143456	85	168	70	163	80	146	78	M64x3	83	13

Eye Bracket (2) Dimensions

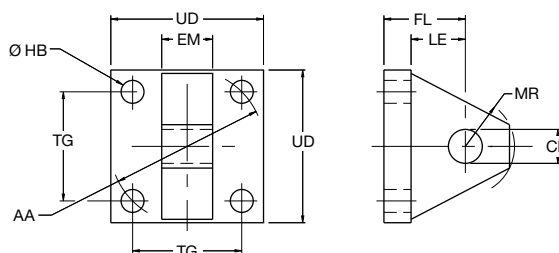

Part No.	CK H9	EM h13	FL	MR max	LE min	AA	HB	TG	UD
144808	10	12	23	12	13	40	5.5	28.3	40
144809	12	16	29	17	19	47	6.6	33.2	45
144810	14	20	29	17	19	59	9.0	41.7	65
144811	20	30	48	29	32	74	13.5	52.3	75
144812	20	30	48	29	32	91	13.5	64.3	90
144813	28	40	59	34	39	117	17.5	82.7	115
144814	36	50	79	50	54	137	17.5	96.9	130
144815	45	60	87	53	57	178	26	125.9	165
144816	56	70	103	59	63	219	30	154.9	205
144817	70	80	132	78	82	269	33	190.2	240

Eye Bracket (2)

Bore Ø	Eye Bracket	Nominal Force kN	Mass kg
25	144808	10.3	0.2
32	144809	16.9	0.3
40	144810	26.4	0.4
50	144811	41.2	1.0
63	144812	65.5	1.4
80	144813	106	3.2
100	144814	165	5.6
125	144815	258	10.5
160	144816	422	15
200	144817	660	20

All dimensions are in millimetres unless otherwise stated.

Plain Rod Eye, Clevis Bracket and Pivot Pin

Thread KK	Plain Rod Eye (4)	Clevis Bracket (5)	Pivot Pin (3)	Nominal Force kN	Mass kg
M10x1.25	143457	143646	143477	10.3	0.5
M12x1.25	143458	143647	143478	16.9	1.0
M14x1.5	143459	143648	143479	26.4	1.3
M16x1.5	143460	143649	143480	41.2	3.2
M20x1.5	143461	143649	143480	65.5	3.8
M27x2	143462	143650	143481	106	6.9
M33x2	143463	143651	143482	165	12.5
M42x2	143464	143652	143483	258	26
M48x2	143465	143653	143484	422	47
M64x3	143466	143654	143485	660	64

Plain Rod Eye

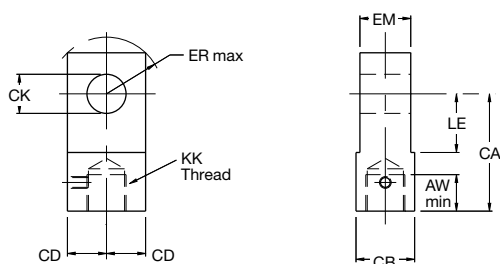

Plain Rod Eye (4) Dimensions

Part No.	AW	CA	CB	CD	CK H9	EM h13	ER	KK	LE min	Mass kg
143457	14	32	18	9	10	12	12	M10x1.25	13	0.08
143458	16	36	22	11	12	16	17	M12x1.25	19	0.15
143459	18	38	20	12.5	14	20	17	M14x1.5	19	0.22
143460	22	54	30	17.5	20	30	29	M16x1.5	32	0.5
143461	28	60	30	20	20	30	29	M20x1.5	32	1.1
143462	36	75	40	25	28	40	34	M27x2	39	1.5
143463	45	99	50	35	36	50	50	M33x2	54	2.5
143464	56	113	65	50	45	60	53	M42x2	57	4.2
143465	63	126	90	56	56	70	59	M48x2	63	11.8
143466	85	168	110	70	70	80	78	M64x3	83	17

Clevis Bracket

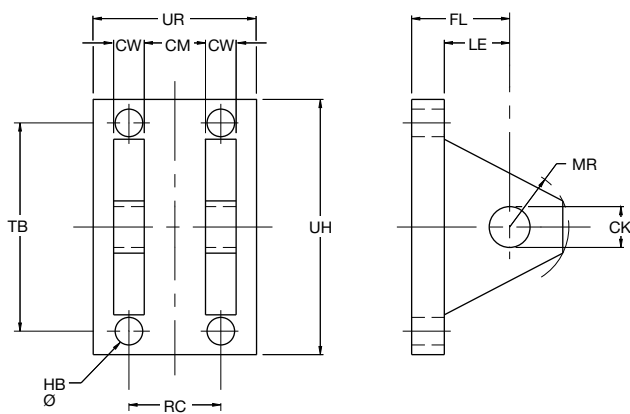

Clevis Bracket (5) Dimensions

Part No.	CK H9	CM A16	CW	FL	MR max	HB	LE min	RC	TB	UR min	UH
143646	10	12	6	23	12	5.5	13	18	47	35	60
143647	12	16	8	29	17	6.6	19	24	57	45	70
143648	14	20	10	29	17	9	19	30	68	55	85
143649	20	30	15	48	29	13.5	32	45	102	80	125
143650	28	40	20	59	34	17.5	39	60	135	100	170
143651	36	50	25	79	50	17.5	54	75	167	130	200
143652	45	60	30	87	53	26	57	90	183	150	230
143653	56	70	35	103	59	30	63	105	242	180	300
143654	70	80	40	132	78	33	82	120	300	200	360

Clevis Bracket (5)

Bore Ø	Clevis Bracket	Nominal Force kN	Mass kg
25	143646	10.3	0.4
32	143647	16.9	0.8
40	143648	26.4	1.0
50	143649	41.2	2.5
63	143649	65.5	2.5
80	143650	106	5.0
100	143651	165	9.0
125	143652	258	20
160	143653	422	31
200	143654	660	41

All dimensions are in millimetres unless otherwise stated.

**Rod Eye with Spherical Bearing,
Mounting Bracket and Pivot Pin**

Thread KK	Rod Eye with Spherical Bearing (6)	Mounting Bracket and Pivot Pin (7)	Nominal Force kN
M10x1.25	145254	145530	10.3
M12x1.25	145255	145531	16.9
M14x1.5	145256	145532	26.4
M16x1.5	145257	145533	41.2
M20x1.5	145258	145534	65.5
M27x2	145259	145535	106
M33x2	145260	145536	165
M42x2	145261	145537	258
M48x2	145262	145538	422
M64x3	145263	145539	660

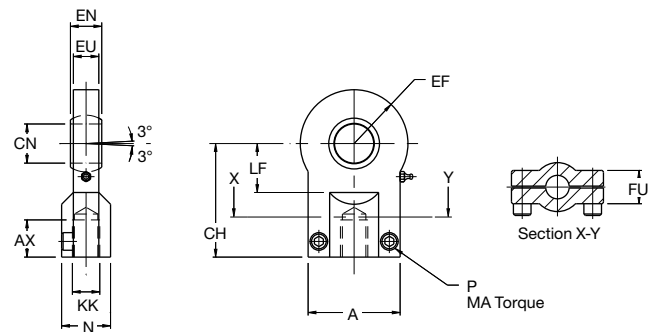

Rod Eye with Spherical Bearing (6) Dimensions

Part No.	A max	AX min	EF max	CH	CN	EN	EU	FU	KK	LF min	N max	MA max Nm	P	Mass kg
145254	40	15	20	42	12 ^{-0.008}	10 ^{-0.12}	8	13	M10x1.25	16	17	10	M6	0.7
145255	45	17	22.5	48	16 ^{-0.008}	14 ^{-0.12}	11	13	M12x1.25	20	21	10	M6	1.3
145256	55	19	27.5	58	20 ^{-0.012}	16 ^{-0.12}	13	17	M14x1.5	25	25	25	M8	2.3
145257	62	23	32.5	68	25 ^{-0.012}	20 ^{-0.12}	17	17	M16x1.5	30	30	25	M8	3.7
145258	80	29	40	85	30 ^{-0.012}	22 ^{-0.12}	19	19	M20x1.5	35	36	45	M10	6.5
145259	90	37	50	105	40 ^{-0.012}	28 ^{-0.12}	23	23	M27x2	45	45	45	M10	11.6
145260	105	46	62.5	130	50 ^{-0.012}	35 ^{-0.12}	30	30	M33x2	58	55	80	M12	23
145261	134	57	80	150	60 ^{-0.015}	44 ^{-0.15}	38	38	M42x2	68	68	160	M16	46
145262	156	64	102.5	185	80 ^{-0.015}	55 ^{-0.15}	47	47	M48x2	92	90	310	M20	95
145263	190	86	120	240	100 ^{-0.020}	70 ^{-0.20}	57	57	M64x3	116	110	530	M24	168

Mounting Bracket and Pivot Pin (7) Dimensions

Part No.	CF K7/h6	CG +0.1, +0.3	CO N9	CP	FM js11	FO js14	GL js13	HB	KC 0, +0.30	LG	LJ	LO	RE js13	SR max	TA js13	UJ	UK
145530	12	10	10	30	40	16	46	9	3.3	28	29	56	55	12	40	75	60
145531	16	14	16	40	50	18	61	11	4.3	37	38	74	70	16	55	95	80
145532	20	16	16	50	55	20	64	14	4.3	39	40	80	85	20	58	120	90
145533	25	20	25	60	65	22	78	16	5.4	48	49	98	100	25	70	140	110
145534	30	22	25	70	85	24	97	18	5.4	62	63	120	115	30	90	160	135
145535	40	28	36	80	100	24	123	22	8.4	72	73	148	135	40	120	190	170
145536	50	35	36	100	125	35	155	30	8.4	90	92	190	170	50	145	240	215
145537	60	44	50	120	150	35	187	39	11.4	108	110	225	200	60	185	270	260
145538	80	55	50	160	190	35	255	45	11.4	140	142	295	240	80	260	320	340
145539	100	70	63	200	210	35	285	48	12.4	150	152	335	300	100	300	400	400

Mounting Bracket and Pivot Pin (7)

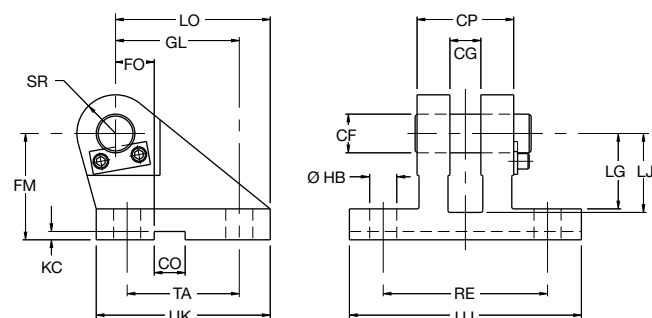

Mounting Bracket and Pin (7)

Bore Ø	Mounting Bracket and Pivot Pin	Nominal Force kN	Mass kg
25	145530	10.3	0.6
32	145531	16.9	1.3
40	145532	26.4	2.1
50	145533	41.2	3.2
63	145534	65.5	6.5
80	145535	106	12
100	145536	165	23
125	145537	258	37
160	145538	422	79
200	145539	660	140

All dimensions are in millimetres unless otherwise stated.

Front Flange Mountings

Style JJ front flange-mounted cylinders, see page 9, incorporate a location diameter for accurate alignment on the mounting surface. The gland retainer is integral with the head on 25, 32 and 40mm bore cylinders, while on 50mm bores and above, the circular retainer is bolted to the head.

Extended Tie Rods

Cylinders may be ordered with extended tie rods in addition to another mounting style. The extended tie rods may then be used for mounting other systems or machine components. An additional set of mounting nuts is supplied.

Foot Mountings and Thrust Keys

The turning moment which results from the application of force by a foot-mounted cylinder must be resisted by secure mounting and effective guidance of the load. The option of a thrust key is recommended to provide positive cylinder location.

25mm and 32mm bore foot-mounted (style C) cylinders, see page 9, are available with an integral key formed from the lower edge of the specially extended gland retainer. To order, select 'P' in the 'Mounting Modification' field of the model code on page 29.

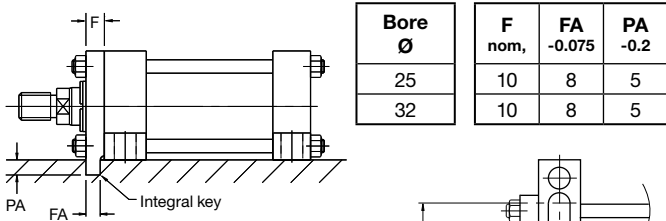

Bore Ø	F nom.	FA -0.075	PA -0.2
25	10	8	5
32	10	8	5

Foot-mounted cylinders of 40mm bore and above use a separate key (supplied) fitted between keyways machined in the foot mounting at the head end of the cylinder and the machine bed. To order, select 'K' in the 'Mounting Modification' field of the model code on page 29. The key supplied corresponds to BS4235/ DIN6885 type B.

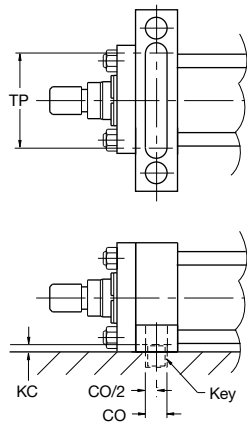

Bore Ø	CO N9	KC min	TP min	Key			
				Width	Height	Length	Part No.
40	12	4	55	12	8	55	0941540040
50	12	4.5	70	12	8	70	0941540050
63	16	4.5	80	16	10	80	0941540063
80	16	5	105	16	10	105	0941540080
100	16	6	120	16	10	120	0941540100
125	20	6	155	20	12	155	0941540125
160*	32	8	190	32	18	190	0941540160
200	40	8	220	40	22	220	0941540200

* Not to ISO 6020/2

Tie Rod Nuts

Tie rod mounting nuts, with lubricated threads, should be to a minimum strength of ISO 898/2 grade 10, torque loaded to the figures shown.

Bore Ø	Tie Rod Nut Torque Nm
25	4.5 - 5.0
32	7.6 - 9.0
40	19.0 - 20.5
50	68 - 71
63	68 - 71
80	160 - 165
100	160 - 165
125	450 - 455
160	815 - 830
200	1140 - 1155

Mounting Bolts

Mounting bolts with a minimum strength of ISO 898/1 grade 10.9 should be used for attaching cylinders to the machine or base. Mounting bolts should be torque loaded to their manufacturer's recommended figures.

Tie Rod Supports

To increase the resistance to buckling of long stroke cylinders, tie rod supports may be fitted. These allow longer than normal strokes to be used without the need for an additional mounting.

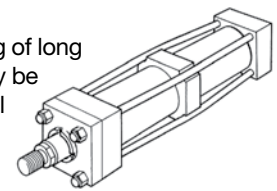

Bore Ø	Stroke (metres)												Number of supports req'd.	
	0.9	1.2	1.5	1.8	2.1	2.4	2.7	3.0	3.3	3.6	3.9	4.2		
25	1	1	2											
32	-	1	1	2	Consult factory									
40	-	-	1	1	1	2	2							
50	-	-	-	1	1	1	1	2	2	2	2	3		
63	-	-	-	-	-	1	1	1	1	1	2	2		
80	-	-	-	-	-	-	-	1	1	1	1	1		
100	-	-	-	-	-	-	-	-	-	1	1	1		

Maximum Stroke Lengths of Unsupported Cylinders

Bore Ø	Intermediate Mounting	End Support Mounting
25		
32	1500	1000
40		
50		
63	2000	1500
80		
100		
125	3000	2000
160		
200	3500	2500

All dimensions are in millimetres unless otherwise stated.

Stroke Tolerances

Standard production stroke tolerances are 0 to +2mm on all bore sizes and stroke lengths. For closer tolerances, please specify the required tolerance plus the operating temperature and pressure. Tolerances of stroke dependent dimensions for each mounting style are shown in the table below.

Mounting Style	Dimensions	Tolerance – for strokes up to 3m
All styles – port dimensions	Y	±2
	PJ	±1.25
JJ (ME5)	ZB	max
HH (ME6)	ZJ	±1
BB (MP1) B (MP3)	XC	±1.25
SBd (MP5)	XO	±1.25
C (MS2)	XS	±2
	ZB	max
	SS	±1.25
D (MT1)	XG	±2
	ZB	max
DB (MT2)	XJ	±1.25
	ZB	max
DD (MT4)	X1	±2
	ZB	max
TD (MX1) TC (MX2) TB (MX3)	BB	+3 0
TB (MX3)	ZB	max
TD (MX1) TB (MX3)	WH	±2
TD (MX1) TC (MX2) TB (MX3)	ZJ	±1

inPHorm

For assistance with the calculation of cylinder bore size, refer to the European cylinder inPHorm selection program HY07-1260/Eur.

Calculation of Cylinder Diameter

Compression or 'Push' Applications

If the piston rod is in compression, use the 'Push Force' table.

1. Identify the operating pressure closest to that required.
2. In the same column, identify the force required to move the load (always rounding up).
3. In the same row, look along to the cylinder bore required.

If the cylinder envelope dimensions are too large, increase the operating pressure, if possible, and repeat the exercise.

Push Force

Bore Ø mm	Bore Area mm ²	Cylinder Push Force in kN						
		10 bar	40 bar	63 bar	100 bar	125 bar	160 bar	210 bar
25	491	0.5	2.0	3.1	4.9	6.1	7.9	10.3
32	804	0.8	3.2	5.1	8.0	10.1	12.9	16.9
40	1257	1.3	5.0	7.9	12.6	15.7	20.1	26.4
50	1964	2.0	7.9	12.4	19.6	24.6	31.4	41.2
63	3118	3.1	12.5	19.6	31.2	39.0	49.9	65.5
80	5027	5.0	20.1	31.7	50.3	62.8	80.4	105.6
100	7855	7.9	31.4	49.5	78.6	98.2	125.7	165.0
125	12272	12.3	49.1	77.3	122.7	153.4	196.4	257.7
160	20106	20.1	80.4	126.7	201.1	251.3	321.7	422.2
200	31416	31.4	125.7	197.9	314.2	392.7	502.7	659.7

Tension or 'Pull' Applications

If the piston rod is in tension, use the 'Deduction for Pull Force' table. To determine the pull force:

1. Follow the procedure for 'push' applications, described above.
2. Using the 'pull' table, identify the force indicated according to the rod and pressure selected.
3. Deduct this from the original 'push' force. The resultant is the net force available to move the load.

If this force is not large enough, repeat the process with a higher system operating pressure or larger cylinder diameter.

Deduction for Pull Force

Piston Rod Ø mm	Piston Rod Area mm ²	Reduction in Force in kN						
		10 bar	40 bar	63 bar	100 bar	125 bar	160 bar	210 bar
12	113	0.1	0.5	0.7	1.1	1.4	1.8	2.4
14	154	0.2	0.6	1.0	1.5	1.9	2.5	3.2
18	255	0.3	1.0	1.6	2.6	3.2	4.1	5.4
22	380	0.4	1.5	2.4	3.8	4.8	6.1	8.0
28	616	0.6	2.5	3.9	6.2	7.7	9.9	12.9
36	1018	1.0	4.1	6.4	10.2	12.7	16.3	21.4
45	1591	1.6	6.4	10.0	15.9	19.9	25.5	33.4
56	2463	2.5	9.9	15.6	24.6	30.8	39.4	51.7
70	3849	3.8	15.4	24.2	38.5	48.1	61.6	80.8
90	6363	6.4	25.5	40.1	63.6	79.6	101.8	133.6
110	9505	9.5	38.0	59.9	95.1	118.8	152.1	199.6
140	15396	15.4	61.6	97.0	154.0	192.5	246.3	323.3

All dimensions are in millimetres unless otherwise stated.



Piston Rod Size Selection

To select a piston rod for compression (push) applications:

1. Determine the type of mounting style and rod end connection to be used. From the Stroke Factor table below, identify which factor corresponds to the application.
2. Using this stroke factor, determine the 'basic length' from the equation:

$$\text{Basic Length} = \text{Net Stroke} \times \text{Stroke Factor}$$

(The Piston Rod Selection Chart, opposite, is prepared for the standard rod extension beyond the face of the gland retainer. For rod extensions greater than standard, add the increase to the net stroke to obtain the 'basic length'.)

3. Calculate the load imposed for the compression application by multiplying the full bore area of the cylinder by the system pressure, or by referring to the Push and Pull Force charts on page 17.

4. Using the Piston Rod Selection Chart, opposite, look along the values of 'basic length' and 'push force' as found in 2 and 3 above, and note the point of intersection.



The correct piston rod diameter is read from the curved line **above** the point of intersection.

For tensile (pull) loads, the rod size is selected by specifying standard cylinders with standard rod diameters and using them at or below the rated pressure.

inPHorm

For accurate sizing, please refer to the European cylinder inPHorm selection program HY07-1260/Eur.

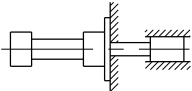
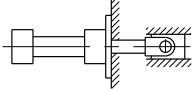
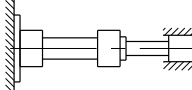
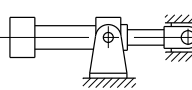
Stroke Factor Selection

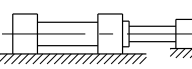
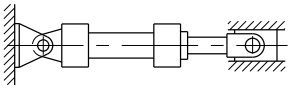
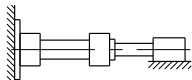
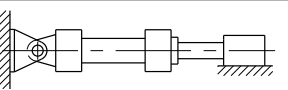
Rod End Connection	Mounting Style	Type of Mounting	Stroke Factor
Fixed and Rigidly Guided	TB, TD, JJ, C		0.5
Pivoted and Rigidly Guided	TB, TD, JJ, C		0.7
Fixed and Rigidly Guided	TC, HH		1.0
Pivoted and Rigidly Guided	D		1.0
Pivoted and Rigidly Guided	TC, HH, DD		1.5
Supported but not Rigidly Guided	TB, TD, JJ, C		2.0
Pivoted and Rigidly Guided	BB, DB, SBd		2.0
Supported but not Rigidly Guided	TC, HH		4.0
Supported but not Rigidly Guided	BB, DB, SBd		4.0

Piston Rod Selection Chart

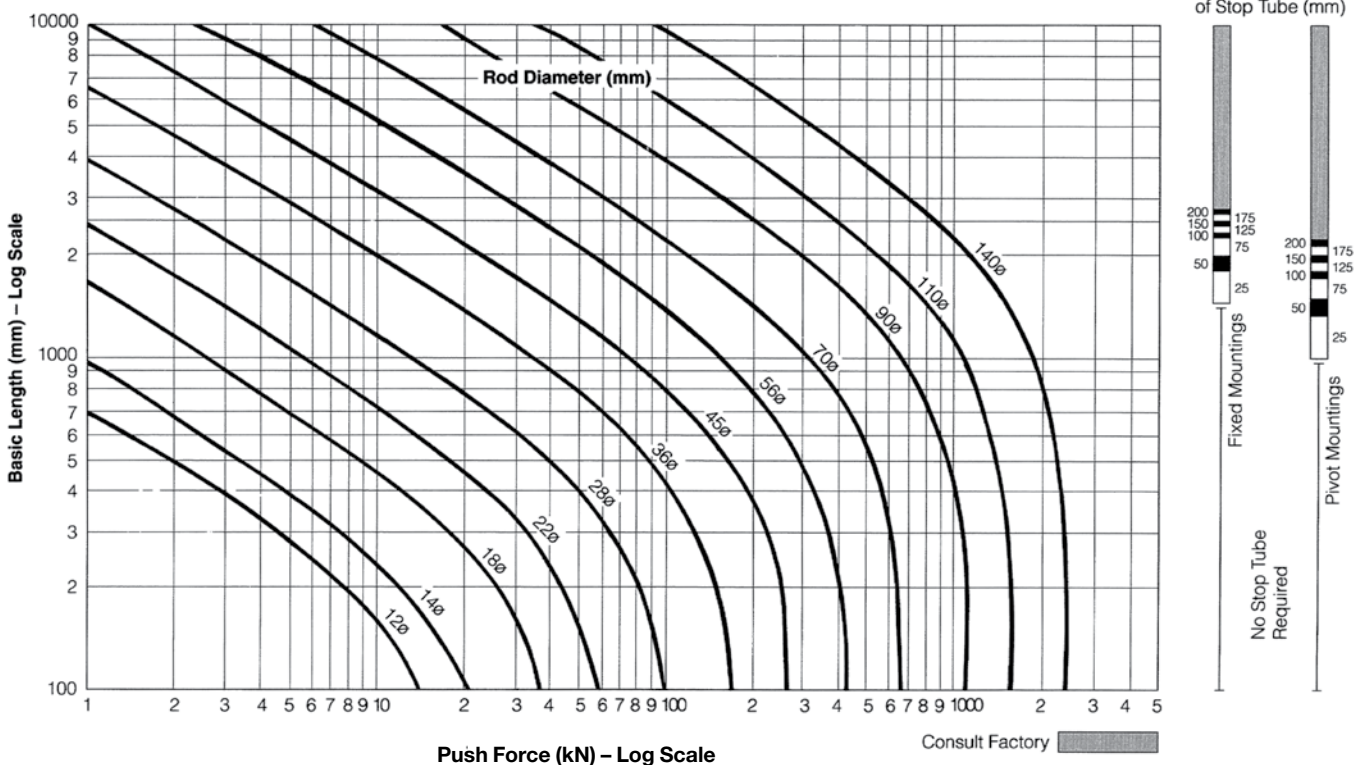

Long Strokes and Stop Tubes

For long stroke cylinders under compressive (push) loads, a stop tube should be used to reduce bearing stress. The required length of stop tube is read from the vertical columns on the right of the chart by following the horizontal band within which the point of intersection lies. Note that stop tube requirements differ for fixed and pivot mounted cylinders.

When specifying a cylinder with a stop tube, please insert an S (Special) and the net stroke of the cylinder in the order code and state the length of the stop tube. Note that net stroke is equal to the gross stroke of the cylinder less the length of the stop tube. The gross stroke determines the envelope dimensions of the cylinder.

If the required length of stop tube is in the region labelled 'consult factory', please submit the following information:

1. Cylinder mounting style.
2. Rod end connection and method of guiding load.
3. Bore and stroke required, length of rod extension (dimensions WF – VE) if greater than standard.
4. Mounting position of cylinder. If at an angle or vertical, specify the direction of the piston rod.
5. Operating pressure of cylinder, if limited to less than the standard pressure for the cylinder selected.

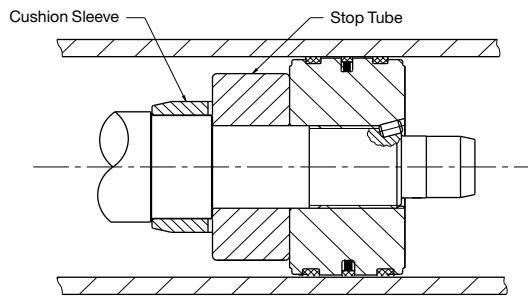

An Introduction to Cushioning

The option of cushioning is recommended as a means of controlling the deceleration of masses, or for applications where piston speeds are in excess of 0.1m/s and the piston will make a full stroke. Cushioning extends cylinder life and reduces undesirable noise and hydraulic shock. Cushions can be supplied at the head and/or cap ends of a cylinder without affecting its envelope or mounting dimensions.

Standard Cushioning

Where specified, HMI and HMD cylinders use cushions which are profiled to give efficient, progressive deceleration. Final speed may be adjusted using the cushion screws. The head and cap cushion performance for each bore size is illustrated in the charts on page 21.

Note that cushion performance will be affected by the use of water or high water-based fluids. Please consult the factory for details.

Alternative Forms of Cushioning

Special designs can be produced to suit applications where the energy to be absorbed exceeds the standard cushion performance. Please consult the factory for further details.

Cushion Length

HMI/HMD cylinders incorporate the longest cushion sleeve and spear that can be accommodated within the standard envelope without reducing the rod bearing and piston bearing lengths – see table of cushion lengths on page 22.

Cushion Calculations

The charts on page 21 show the energy absorption capacity for each bore/rod combination at the head (annulus) and the cap (full bore) ends of the cylinder. The charts are valid for piston velocities in the range 0.1 to 0.3m/s. For velocities between 0.3 and 0.5m/s, the energy values derived from the charts should be reduced by 25%. For velocities of less than 0.1m/s where large masses are involved, and for velocities of greater than 0.5m/s, a special cushion profile may be required. Please consult the factory for details.

The cushion capacity of the head end is less than that of the cap owing to the pressure intensification effect across the piston. The energy absorption capacity of the cushion decreases with drive pressure, which in normal circuits is the relief valve pressure.

inPHorm

Cushioning requirements can be calculated automatically for individual cylinder/load combinations using the European cylinder inPHorm selection program HY07-1260/Eur.

Formulae

Cushioning calculations are based on the formula $E = \frac{1}{2}mv^2$ for horizontal applications. For inclined or vertically downward or upward applications, this is modified to:

$$E = \frac{1}{2}mv^2 + mgl \times 10^{-3} \times \sin\alpha$$

(for inclined or vertically downward direction of mass)

$$E = \frac{1}{2}mv^2 - mgl \times 10^{-3} \times \sin\alpha$$

(for inclined or vertically upward direction of mass)

Where:

- E = energy absorbed in Joules
- g = acceleration due to gravity = 9.81m/s²
- v = velocity in metres/second
- l = length of cushion in millimetres (see page 22)
- m = mass of load in kilogrammes (including piston, rod and rod end accessories, see pages 13-15 and 22)
- α = angle to the horizontal in degrees
- p = pressure in bar

Example

The example shows how to calculate the energy developed by masses moving in a straight line. For non-linear motion, other calculations are required; please consult the factory.

The example assumes that the bore and rod diameters are already appropriate for the application. The effects of friction on the cylinder and load have been ignored.

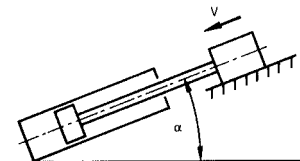

- Selected bore/rod 160/70mm (No.1 rod) with cap end cushion.
- Pressure = 160 bar
- Mass = 10000kg
- Velocity = 0.4m/s
- Cushion length = 41mm
- α = 45°
- Sinα = 0.70

$$E = \frac{1}{2}mv^2 + mgl \times 10^{-3} \times \sin$$

$$E = \frac{10000 \times 0.4^2}{2} + 10000 \times 9.81 \times \frac{41}{10^3} \times 0.70$$

$$E = 800 + 2815 = 3615 \text{ Joules}$$

Note that, as velocity is greater than 0.3m/s, the energy absorption figures obtained from the charts on page 21 should be reduced by 25% – see Cushion Calculations, above. Comparison with the cushioning chart curve for this cylinder shows an energy capacity for the cap end of 5600 Joules. Reducing this by 25% gives a capacity of 4200 Joules, so the standard cushion can safely decelerate the 3615 Joules in this example.

Where cushion performance figures are critical, our engineers can run a computer simulation to determine accurate cushion performance – please contact the factory for details.

Cushion Energy Absorption Capacity

The cushion energy absorption capacity data shown below is based on the maximum fatigue-free pressure developed in the

tube. If working life cycle applications of less than 10⁶ cycles are envisaged, then greater energy absorption figures can be applied. Please consult the factory for further information.

Head End (Rod Outward)

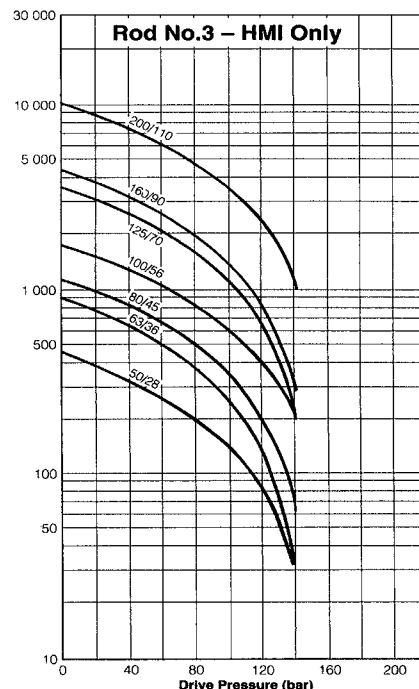
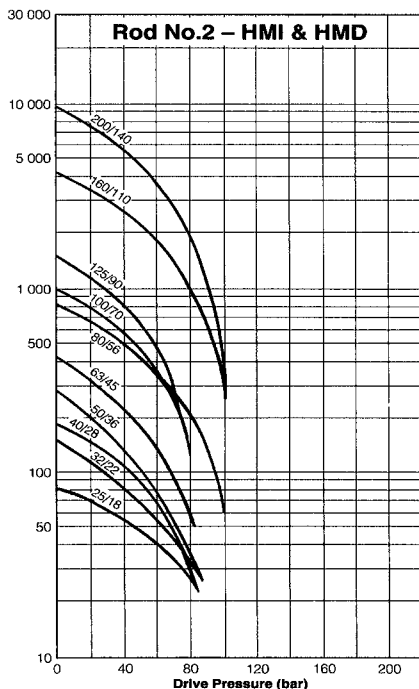
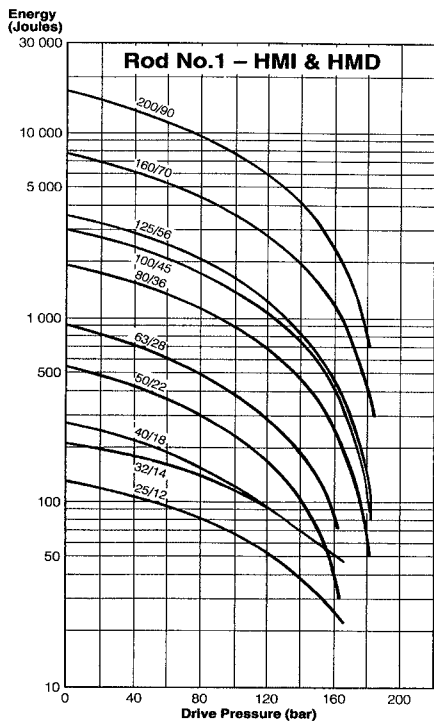

Cap End (Rod Inward)

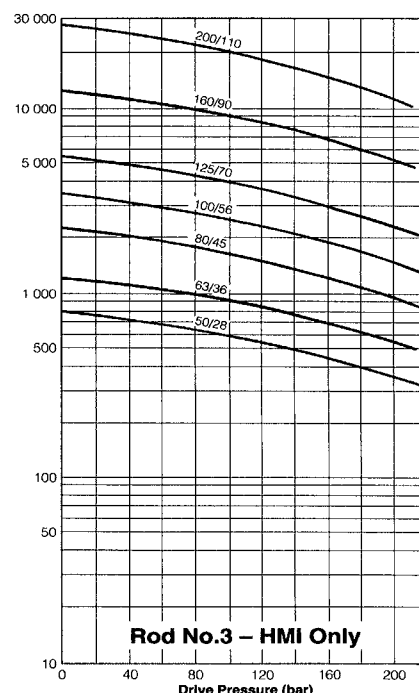
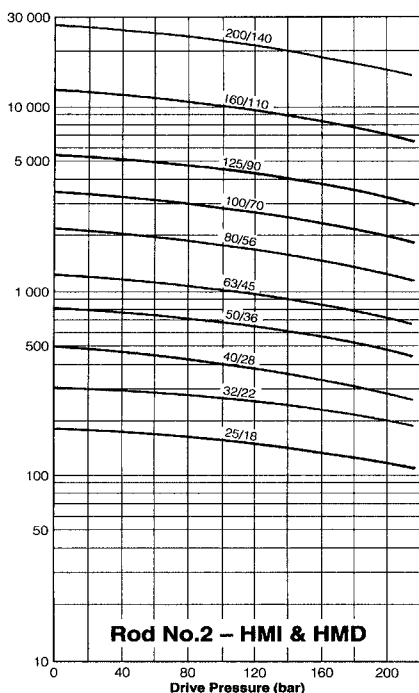
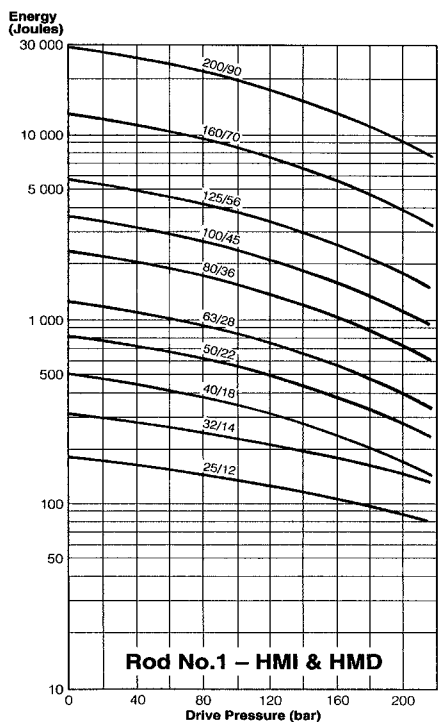

Cushioning

Cushion Length, Piston and Rod Mass

Bore Ø	Rod Number	Rod Ø	Cushion Length – ISO & DIN				– ISO Only		Piston & Rod at Zero Stroke kg	Rod Only per 10mm Stroke kg
			Rod No. 1		Rod No. 2		Rod No. 3			
			Head	Cap	Head	Cap	Head	Cap		
25	1	12	22	20	24	20	-	-	0.12	0.01
	2	18							0.16	0.02
32	1	14	24	20	24	20	-	-	0.23	0.01
	2	22							0.30	0.03
40	1	18	29	29	29	30	-	-	0.44	0.02
	2	28							0.60	0.05
50	1	22	29	29	29	29	29	29	0.70	0.03
	2	36							0.95	0.08
	3	28							0.80	0.05
63	1	28	29	29	29	29	29	29	1.20	0.05
	2	45							1.60	0.12
	3	36							1.35	0.08
80	1	36	35	32	27	32	35	32	2.30	0.08
	2	56							2.90	0.19
	3	45							2.50	0.12
100	1	45	35	32	26	32	29	32	4.00	0.12
	2	70							5.10	0.30
	3	56							4.40	0.19
125	1	56	28	32	27	32	27	32	7.10	0.19
	2	90							9.40	0.50
	3	70							8.00	0.30
160	1	70	34	41	34	41	34	41	13.70	0.30
	2	110							17.20	0.75
	3	90							15.30	0.50
200	1	90	46	56	49	56	50	56	27.00	0.50
	2	140							34.00	1.20
	3	110							30.00	0.75

All dimensions are in millimetres unless otherwise stated.

Pressure Limitations – Push and Pull Loads

Push Loads

Where a piston rod is in compression (push load) and attachments are securely butted against the rod shoulder, fatigue is not an issue for rod ends with two wrench flats. Due to the reduced shoulder area where four wrench flats are supplied, 12mm and 14mm diameter piston rods with four flats should be restricted to a maximum of 160 bar working pressure – see Rod End Wrench Flats, page 6.

Pull Loads

Under pull load conditions, the threads between the piston and piston rod may be subjected to full load variations. Under these

conditions, fatigue failure must be considered. Most piston rod options are fatigue free at 210 bar. The charts below show the fatigue life profiles of only those piston rods which are affected by fatigue at or below the 210 bar nominal pressure.

Double Rodded Cylinders

The method of attachment of the piston rods to the piston in double rodded cylinders results in one rod being stronger than the other – see page 12. The pressure limitations for the stronger rod are identical to those shown on the charts for the equivalent single rod assembly. The chart for the double rod cylinder with codes 1 and 4 rod end styles, below, applies to the weaker rod only.

Fatigue Life of Piston Rods under Pull Load Conditions

Note: Curves are labelled according to bore size and rod number, eg: 100/3 is a cylinder with 100mm bore, fitted with a No.3 rod.

Rod End Codes 1 and 4

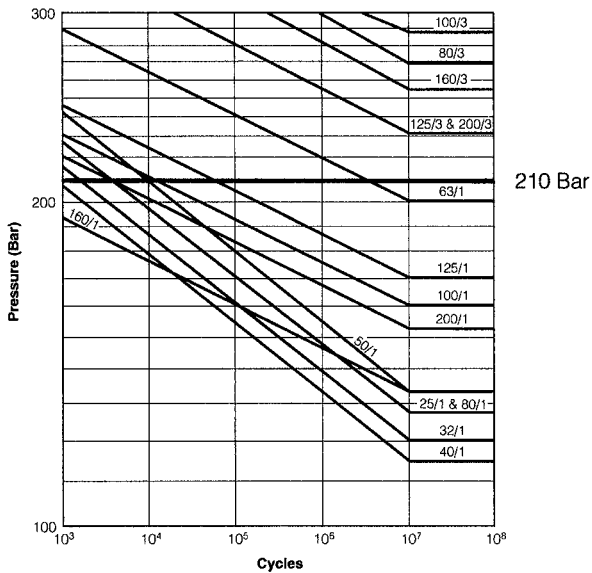

Rod End Codes 5 and 9

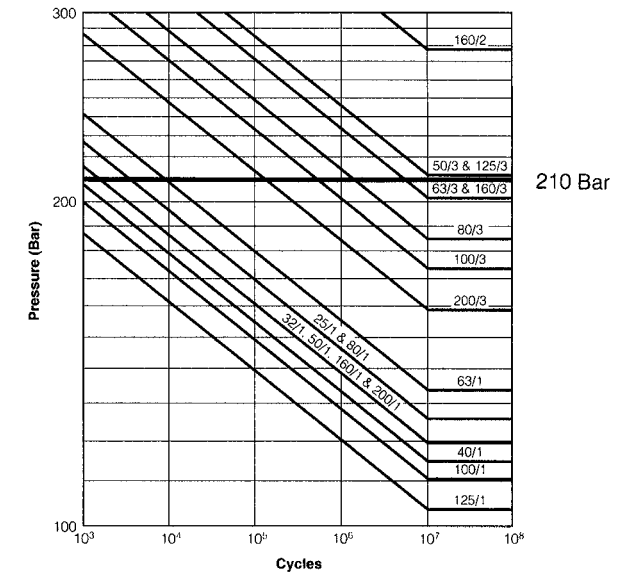

Rod End Codes 2 and 7

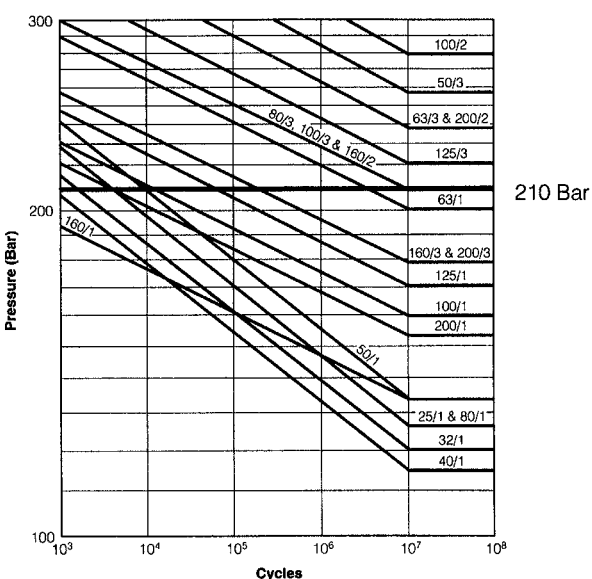

Double Rod Codes 1 and 4

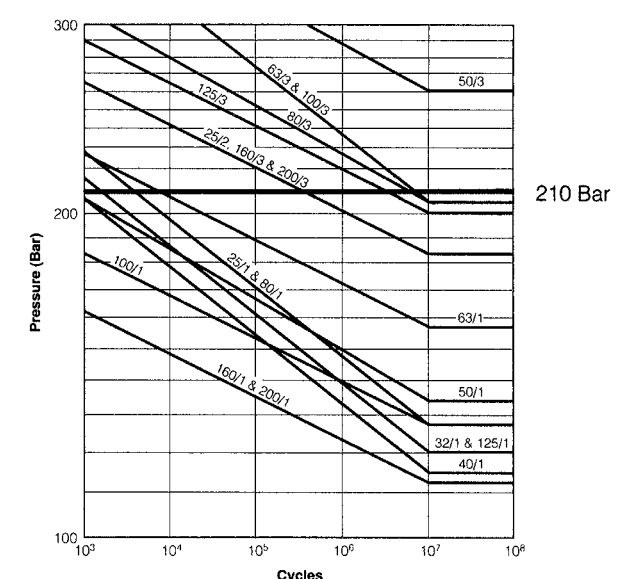

Ports, Locations and Piston Speeds

Port Types

Series HMI and HMD cylinders are supplied with BSP parallel threaded ports as standard, or with metric threaded ports to DIN 3852 Part 1 or ISO 6149, spotfaced for sealing washers. For higher speed applications, oversize ports or additional ports are available.

25mm and 32mm Bore Cylinders

The head depth is increased by 5mm in the port face to provide the necessary thread length. On 25 and 32mm bore JJ mount cylinders with port in positions 2 or 4, head depth E is increased by 5mm in position 1. At the cap ends of cylinders with oversize ports, 20mm high port bosses are fitted. Note that Y and PJ dimensions may vary slightly to accommodate oversize ports – please contact the factory where these dimensions are critical.

Port Size and Piston Speed

The tables opposite show piston speeds for standard and oversize ports and connecting lines where the velocity of the fluid is 5m/s. If the desired piston speed results in a fluid flow in excess of 5m/s, larger lines with two ports per cap should be considered. Parker recommends that a flow rate of 12m/s in connecting lines should not be exceeded.

Speed Limitations

Where large masses are involved, or piston speeds exceed 0.1m/s and the piston will make a full stroke, cushions are recommended – see page 20. For cylinders with oversize ports and with a fluid velocity exceeding 8m/s into the cap end, please contact the factory with details of the application.

Port and Cushion Adjustment Location

The table below shows standard positions for ports, and cushion adjusting screws where fitted. For cylinders up to 125mm bore, a cartridge type adjuster is fitted which may protrude by up to 3mm on 25mm and 32mm bore cylinders. Above 125mm bore, a flush fitting socket-headed adjuster is used.

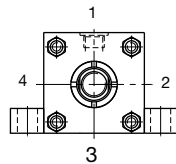

Bore Ø	Standard Cylinder Ports				
	Port Size BSP/G inches	Port Size Metric ¹	Bore of Connecting Lines	Cap End Flow in l/min @ 5m/s	Piston Speed m/s
25	G ¹ / ₄	M14x1.5	7	11.5	0.39
32	G ¹ / ₄	M14x1.5	7	11.5	0.24
40	G ³ / ₈	M18x1.5	10	23.5	0.31
50	G ¹ / ₂	M22x1.5	13	40	0.34
63	G ¹ / ₂	M22x1.5	13	40	0.21
80	G ³ / ₄	M27x2	15	53	0.18
100	G ³ / ₄	M27x2	15	53	0.11
125	G1	M33x2	19	85	0.12
160	G1	M33x2	19	85	0.07
200	G1 ¹ / ₄	M42x2	24	136	0.07

Bore Ø	Oversize Cylinder Ports (Not to DIN 24 554)				
	Port Size BSP/G inches	Port Size Metric ¹	Bore of Connecting Lines	Cap End Flow in l/min @ 5m/s	Piston Speed m/s
25	G ³ / ₈ ²	M18x1.5 ^{2,3}	10	23.5	0.80
32	G ³ / ₈ ²	M18x1.5 ^{2,3}	10	23.5	0.48
40	G ¹ / ₂	M22x1.5 ³	13	40	0.53
50	G ³ / ₄	M27x2 ³	15	53	0.45
63	G ³ / ₄	M27x2 ³	15	53	0.28
80 ⁴	G1	M33x2	19	85	0.28
100 ⁴	G1	M33x2	19	85	0.18
125 ⁴	G1 ¹ / ₄	M42x2	24	136	0.18
160 ⁴	G1 ¹ / ₄	M42x2	24	136	0.11
200 ⁴	G1 ¹ / ₂	M48x2	30	212	0.11

¹ Not to DIN 24 554

² 20mm high port bosses fitted at cap end

³ ISO 6149 ports are not available on some bore/rod combinations

⁴ Consult factory – available on certain bore sizes only. Not recommended for JJ mountings at pressures above 100 bar

Positions of Ports and Cushion Screws in Head and Cap	
Head	Port Cushion
Cap	Port Cushion

Mounting Styles – ISO and DIN																														
TB, TC and TD				JJ ⁵				HH				C ⁶	B and BB				SBd				D		DB				DD			
1	2	3	4	1	2	3	4	1	2	3	4	1	1	2	3	4	1	2	3	4	1	3	1	2	3	4	1	2	3	4
2	3	4	1	3	3	1	1	3	4	1	2	2	2	3	4	1	2	3	4	1	3	1	3	4	1	2	3	4	1	2
1	2	3	4	1	2	3	4	1	2	3	4	1	1	2	3	4	1	2	3	4	1	2	3	4	1	3	1	2	3	4
2	3	4	1	3	4	1	2	3	3	1	1	2	2	3	4	1	2	3	4	1	3	4	1	2	3	1	3	4	1	2

⁵ JJ port positions shown apply to all HMI cylinders, and to 125-200mm bore HMD. For HMD cylinders up to 100mm bore, ports can only be fitted in positions 1 and 3, with cushion adjusting screws in the opposite face.

⁶ Ports in positions 2 and 4 can be fitted, but will be positioned off-centre. On 25 and 32mm bore cylinders, these are only available with No.1 rods.

All dimensions are in millimetres unless otherwise stated.

Seals and Fluid Data

Fluid Group	Seal Materials – a combination of:	Fluid Medium to ISO 6743/4-1982	Temperature Range
1	Nitrile (NBR), PTFE, Polyamide, enhanced polyurethane (AU)	Mineral Oil HH, HL, HLP, HLP-D, HM, HV, MIL-H-5606 oil, air, nitrogen	-20°C to +80°C
2	Nitrile (NBR), PTFE, Polyamide	Water glycol (HFC)	-20°C to +60°C
5	Fluorocarbon elastomer (FPM), PTFE, Polyamide	Fire resistant fluids based on phosphate esters (HFD-R) Also suitable for hydraulic oil at high temperatures or in hot environments. Not suitable for use with Skydrol. See fluid manufacturer's recommendations.	-20°C to +150°C
6	Various compounds including nitrile, polyamide, enhanced polyurethane, fluorocarbon elastomers and PTFE	Water Oil in water emulsion 95/5 (HFA)	+5°C to +55°C
7		Water in oil emulsion 60/40 (HFB)	+5°C to +60°C

Special Seals

Special seals, including seals for use with 'green fluids', can be supplied. Please insert an S (Special) in the order code and specify fluid medium when ordering.

Low Friction Seals

For low pressure applications, and applications where very low friction and an absence of stick-slip are important, low friction seals are available – see page 5.

Water Service

Modifications for use with water as the fluid medium include a stainless steel piston rod and plating of internal surfaces. When ordering, please specify the maximum operating pressure or load/speed conditions, as the stainless steel rod is of lower tensile strength than the standard material.

Parker Hannifin warrants cylinders modified for use with water or water based fluids to be free of defects in materials and workmanship, but cannot accept responsibility for premature failure caused by corrosion, electrolysis or mineral deposits in the cylinder.

Masses – Series HMI and HMD Cylinders

Bore Ø	Rod Ø	Mounting Styles – Weight at Zero Stroke						Weight per 10mm Stroke kg		
		TB, TC, TD kg	C kg	JJ, HH kg	B, BB, SBd kg	D, DB kg	DD kg			
25	12	1.2	1.4	1.5	1.4	1.3	1.5	0.05		
	1.6						0.06			
32	14	1.6	1.9	2.0	1.9	1.7	2.0	0.06		
	1.7						0.08			
40	18	3.7	4.0	4.7	4.2	3.9	4.6	0.09		
	3.8						0.12			
50	22	5.9	6.5	7.2	7.0	6.3	7.9	0.14		
	36						6.0	6.6	7.3	7.1
63	28	8.5	9.7	10	10	8.9				
	45						8.6	9.8	9.0	9.1
80	36	8.7	9.9	16	18	19				
	56						0.32			
100	45	22	24	25	28	23	26	0.40		
	70						23	25	26	29
125	56	42	44	48	53	43				
	90						43	45	49	54
160	70	69	73	78	90	71				
	110						70	74	79	92
200	90	122	129	138	157	127				
	140						123	130	158	128
110	124	131	140	160	129	155				

Masses for accessories begin on page 13.

All dimensions are in millimetres unless otherwise stated.



Service Assemblies and Seal Kits

When ordering Service Assemblies and Seal Kits, please refer to the identification plate on the cylinder body, and supply the following information:

Serial Number - Bore - Stroke - Model Number - Fluid Type

Key to Part Numbers

- 1 Head
- 7 Cap
- 14 Gland/bearing cartridge
- 15 Cylinder body
- 17 Piston
- 18 Cushion sleeve
- 19 Tie rod
- 23 Tie rod nut
- 26 Back-up washer (not 25–50mm bore cylinders)
- 27 Retainer
- 34 Piston rod – single rod, no cushion
- 35 Piston rod – single rod, cushion at head end
- 36 Piston rod – single rod, cushion at cap end
- 37 Piston rod – single rod, cushion at both ends
- 40 Wiperseal – for 14 and 122
- 41 Lipseal – for 14

- 122 Low Friction gland cartridge
- 123 Stepseal for 122
- 124 Pre-load ring for stepseal 123
- 125 Standard piston seal
- 126 Energising ring for standard seal 125
- 127 Wear ring for standard piston
- 128 LoadMaster piston seal
- 129 Energising ring for LoadMaster seal 128
- 130 Wear ring for LoadMaster piston
- 131 Low Friction piston seal
- 132 Energising ring for Low Friction seal 131
- 133 Wear ring for Low Friction piston

¹ Not illustrated

² See page 12 –

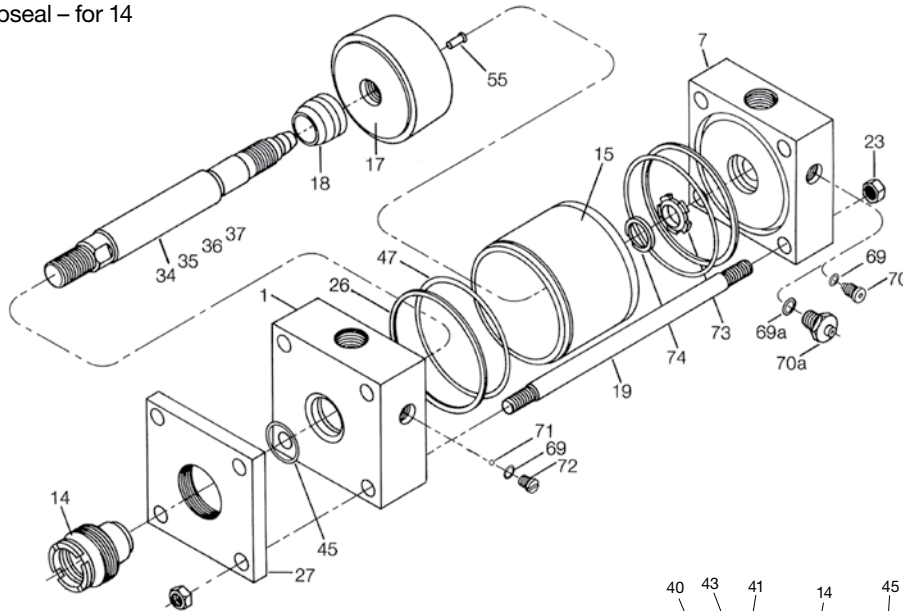

- 43 Back-up washer, gland lipseal 41 (Group 5 seals)
- 45 O-ring – gland/head
- 47 O-ring – cylinder body
- 55 Locking pin – piston/rod
- 57¹ Piston rod – double (stronger²) rod, no cushion
- 58¹ Piston rod – double (stronger²) rod, cushion one end
- 60¹ Piston rod – double (weaker²) rod, no cushion
- 61¹ Piston rod – double (weaker²) rod, cushion one end
- 69 O-ring – needle valve and check valve screws
- 69a O-ring – cartridge-type needle valve
- 70 Needle valve, cushion adjustment
- 70a Needle valve assembly, cartridge type
- 71 Ball – cushion check valve (bore sizes above 100mm)
- 72 Cushion check valve screw (bore sizes above 100mm)
- 73 Floating cushion bush
- 74 Retaining ring for cushion bush

Piston Rod Ø	Gland Cartridge Wrench	Spanner Wrench
12	69590	11676
14	69590	11676
18	84765	11676
22	69591	11676
28	84766	11703
36	69592	11703
45	69593	11677
56	69595	11677
70	69596	11677
90	84768	11677
110	–	–
140	–	–

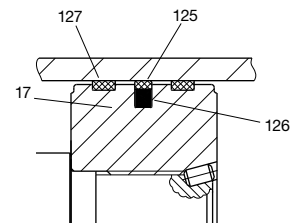

Standard Piston

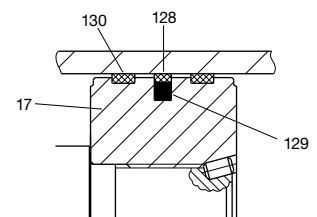

LoadMaster Piston

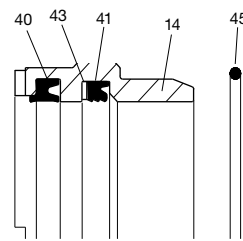

Gland Cartridge and Seals

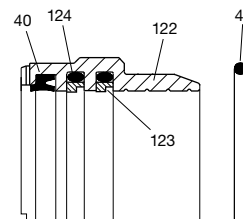

Low Friction Gland and Seals

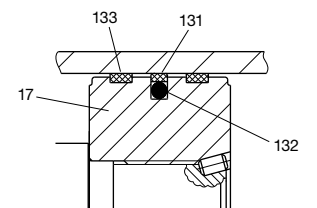

Low Friction Piston

Seal Kits for Pistons and Glands

(see key to part numbers opposite)

Gland Service Cartridge Kit Contains items 14, 40, 41, 43, 45. Where the original gland incorporates a gland drain, please consult the factory.

Gland Service Kit Contains items 40, 41, 43, 45.

Low Friction Gland Service Cartridge Kit Contains items 122, 40, 45, plus two each of 123 and 124.

Low Friction Gland Service Kit Contains items 40 and 45, plus two each of 123 and 124.

Rod Ø	Gland Service Cartridge Kit*	Gland Service Kit*	Low Friction Gland Service Cartridge Kit*	Low Friction Gland Service Kit*
12	RG2HM0121	RK2HM0121	RG2HMF0121	RK2HMF0121
14	RG2HM0141	RK2HM0141	RG2HMF0141	RK2HMF0141
18	RG2HM0181	RK2HM0181	RG2HMF0181	RK2HMF0181
22	RG2HM0221	RK2HM0221	RG2HMF0221	RK2HMF0221
28	RG2HM0281	RK2HM0281	RG2HMF0281	RK2HMF0281
36	RG2HM0361	RK2HM0361	RG2HMF0361	RK2HMF0361
45	RG2HM0451	RK2HM0451	RG2HMF0451	RK2HMF0451
56	RG2HM0561	RK2HM0561	RG2HMF0561	RK2HMF0561
70	RG2HM0701	RK2HM0701	RG2HMF0701	RK2HMF0701
90	RG2HM0901	RK2HM0901	RG2HMF0901	RK2HMF0901
110	RG2HM1101	RK2HM1101	RG2HMF1101	RK2HMF1101
140	RG2HM1401	RK2HM1401	RG2HMF1401	RK2HMF1401

Piston Service Kit, Standard Seals Contains two of item 26 (not 25-50mm bore), two of items 47 and 127 and one each of items 125 and 126.

Piston Service Kit, LoadMaster Seals Contains two of item 26 (not 25-50mm bore), two of items 47 and 130 and one each of items 128 and 129.

Piston Service Kit, Low Friction Seals Contains two of item 26 (not 25-50mm bore), two of items 47 and 133 and one each of items 131 and 132.

Bore Ø	Piston Service Kit Standard Seals*	Piston Service Kit LoadMaster Seals*	Piston Service Kit Low Friction Seals*
25	PN025HM001	PZ025HM001	PF025HM001
32	PN032HM001	PZ032HM001	PF032HM001
40	PN040HM001	PZ040HM001	PF040HM001
50	PN050HM001	PZ050HM001	PF050HM001
63	PN063HM001	PZ063HM001	PF063HM001
80	PN080HM001	PZ080HM001	PF080HM001
100	PN100HM001	PZ100HM001	PF100HM001
125	PN125HM001	PZ125HM001	PF125HM001
160	PN160HM001	PZ160HM001	PF160HM001
200	PN200HM001	PZ200HM001	PF200HM001

*** Seal Groups – Ordering**

The part numbers shown in the tables above are for Group 1 seals, denoted by the last character of each part number. For Group 2, 5, 6 or 7 seals, substitute a '2', '5', '6' or '7' for the '1' at the end of the number sequence.

Service Assembly Kits

(see key to part numbers opposite)

Head Assembly

Non-cushioned: 1, 26, 47

Cushioned: 1, 26, 47, 69, (69a), 70, (70a), 71, 72

Cap Assembly

Non-cushioned: 7, 26, 47

Cushioned: 7, 26, 47, 69, (69a), 70, (70a), 73, 74

Cylinder Body

All types: 15

Cushion Screw/Cartridge Assembly

Screw type: 69, 70

Cartridge type: 69a, 70a

Check Valve Screw Assembly

Screw type: 69, 71, 72 (bore sizes above 100mm)

Piston Rod Assemblies

These kits contain a complete piston and rod assembly of the appropriate type – Standard, LoadMaster or Low Friction.

Piston Assemblies

Standard: 17, 125, 126, 127 x 2

LoadMaster: 17, 128, 129, 130 x 2

Low Friction: 17, 131, 132, 133 x 2

Rod Assemblies

Single rod, non-cushioned: 34

Single rod, cushioned head: 35, 18

Single rod, cushioned cap: 36

Single rod, cushioned both ends: 37, 18

Double rod, non-cushioned: 57, 60,

Double rod, cushioned stronger end: 58, 60, 18

Double rod, cushioned weaker end: 58, 61, 18

Double rod, cushioned both ends: 58, 61, 18 x 2

Repairs

Although HMI and HMD cylinders are designed to make maintenance as easy as possible, some operations can only be carried out satisfactorily in our factory or by an authorised Parker distributor. It is standard policy to fit a cylinder returned for repair with those replacement parts which are necessary to return it to 'as good as new' condition. Should the condition of the returned cylinder be such that repair would be uneconomical, you will be notified.

All dimensions are in millimetres unless otherwise stated.

HMI and HMD Ranges

All rod ends can be supplied with two or four wrench flats – see Pressure Limitations, page 23.

HMI cylinders are available with all of the rod sizes, rod end styles and rod end threads shown in the table below.

HMD cylinders are only available with rod numbers 1 and 2, and only with the rod end threads highlighted in yellow in the table.

The desired combination of rod diameter, rod end thread and number of wrench flats is identified from the table below and selected in the order code on page 29.

Rod End Codes 5 and 9 – Short Stroke Cylinders

Code 5 or 9 (female) rod ends should not be used on 160mm or 200mm bore cylinders with a stroke of 50mm or less. Please consult the factory, with details of the application.

Rod End Code 3

Non-standard piston rod ends are designated Code 3. A dimensional sketch or description should accompany the order. Please specify dimensions KK or KF, A, rod stand out (WF – VE) and thread form.

Rod End Codes 1, 2, 4 & 7 – All Except JJ Mount

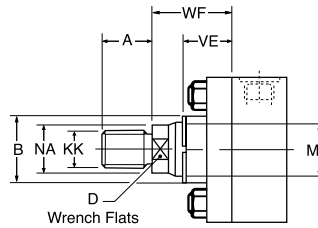

Rod End Codes 1, 2, 4 & 7 – JJ Mount

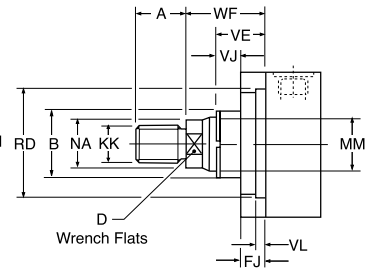

Rod End Codes 5 & 9 – All Except JJ Mount

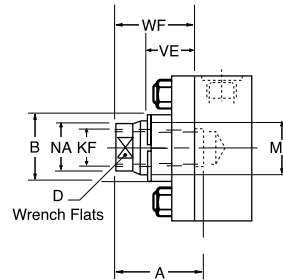

Rod End Codes 5 & 9 – JJ Mount

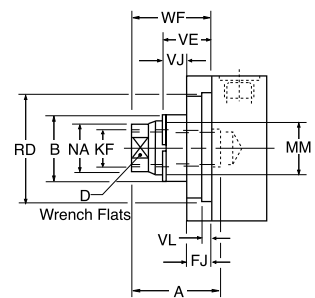

Piston Rod End Dimensions

– Check pressure limitations on page 23

Bore Ø	Rod No.	MM Rod Ø	Code 1 (4 Flats) and Code 4 (2 Flats)		Code 2 (4 Flats) and Code 7 (2 Flats)		Code 5 (4 Flats) and Code 9 (2 Flats)		B f9	D	NA	VE	WF
			KK	A	KK	A	KF	A					
25	1	12	M10x1.25	14	–	–	M8x1	14	24	10	11	16	25
	2	18	M14x1.5	18	M10x1.25	14	M12x1.25	18	30	15	17	16	
32	1	14	M12x1.25	16	–	–	M10x1.25	16	26	12	13	22	35
	2	22	M16x1.5	22	M12x1.25	16	M16x1.5	22	34	18	21	22	
40	1	18	M14x1.5	18	–	–	M12x1.25	18	30	15	17	16	35
	2	28	M20x1.5	28	M14x1.5	18	M20x1.5	28	42	22	26	22	
50	1	22	M16x1.5	22	–	–	M16x1.5	22	34	18	21	22	41
	2	36	M27x2	36	M16x1.5	22	M27x2	36	50	30	34	25	
	3	28	M20x1.5	28	M16x1.5	22	M20x1.5	28	42	22	26	22	
63	1	28	M20x1.5	28	–	–	M20x1.5	28	42	22	26	22	48
	2	45	M33x2	45	M20x1.5	28	M33x2	45	60	39	43	29	
	3	36	M27x2	36	M20x1.5	28	M27x2	36	50	30	34	25	
80	1	36	M27x2	36	–	–	M27x2	36	50	30	34	25	51
	2	56	M42x2	56	M27x2	36	M42x2	56	72	48	54	29	
	3	45	M33x2	45	M27x2	36	M33x2	45	60	39	43	29	
100	1	45	M33x2	45	–	–	M33x2	45	60	39	43	29	57
	2	70	M48x2	63	M33x2	45	M48x2	63	88	62	68	32	
	3	56	M42x2	56	M33x2	45	M42x2	56	72	48	54	29	
125	1	56	M42x2	56	–	–	M42x2	56	72	48	54	29	57
	2	90	M64x3	85	M42x2	56	M64x3	85	108	80	88	32	
	3	70	M48x2	63	M42x2	56	M48x2	63	88	62	68	32	
160	1	70	M48x2	63	–	–	M48x2	63	88	62	68	32	57
	2	110	M80x3	95	M48x2	63	M80x3	95	133	100	108	32	
	3	90	M64x3	85	M48x2	63	M64x3	85	108	80	88	32	
200	1	90	M64x3	85	–	–	M64x3	85	108	80	88	32	57
	2	140	M100x3	112	M64x3	85	M100x3	112	163	128	138	32	
	3	110	M80x3	95	M64x3	85	M80x3	95	133	100	108	32	

JJ Mount only			
VL min	RD f8	VJ	FJ
3	38	6	10
3	42	12	10
3	62	6	10
		12	
4	74	6	16
		9	
		6	
4	75	6	16
		13	
4	88	9	16
		5	
4	105	9	20
		5	
5	92	7	22
		10	
5	125	7	22
		10	
5	105	9	20
		10	
5	150	10	22
		10	
5	125	10	22
		10	
5	170	7	25
		10	
5	150	10	22
		7	
5	210	7	25
		10	

All dimensions are in millimetres unless otherwise stated.

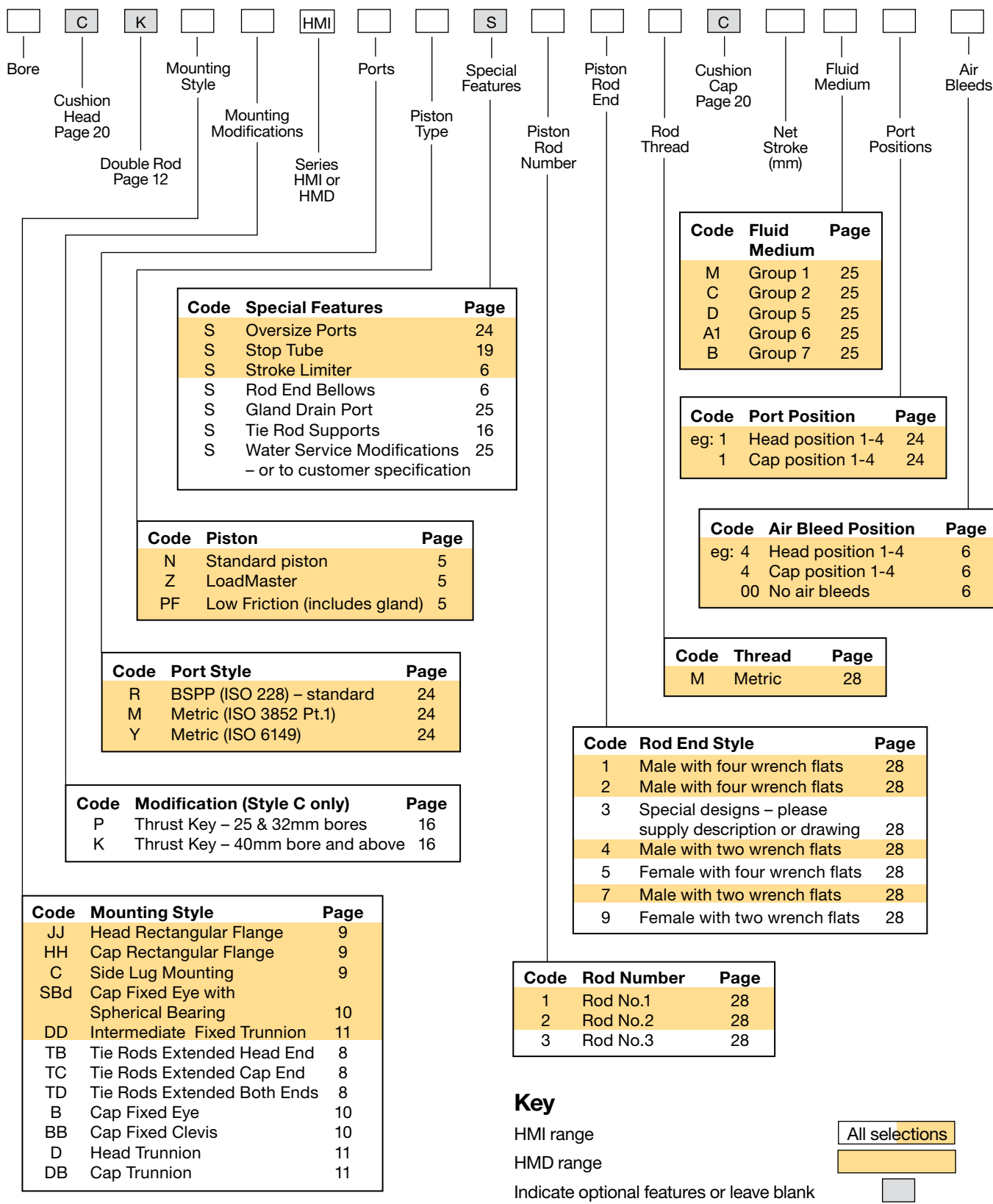

Double Rod Cylinders – Example

100	K	JJ	HMD	R	N	1	4	M	1	4	M	125	A1	11	44
-----	---	----	-----	---	---	---	---	---	---	---	---	-----	----	----	----

Accessories

Please state on order whether accessories are to be fitted to the cylinder or supplied separately.

Sales Offices

AE – United Arab Emirates,
Abu Dhabi
Tel: +971 2 67 88 587

AR – Argentina, Buenos Aires
Tel: +54 3327 44 4129

AT – Austria, Wiener Neustadt
Tel: +43 (0)2622 23501-0

AT – Austria, Wiener Neustadt
(Eastern Europe)
Tel: +43 (0)2622 23501 970

AU – Australia, Castle Hill
Tel: +61 (0)2-9634 7777

AZ – Azerbaijan, Baku
Tel: +994 50 2233 458

BE – Belgium, Nivelles
Tel: +32 (0)67 280 900

BR – Brazil, Cachoeirinha RS
Tel: +55 51 3470 9144

BY – Belarus, Minsk
Tel: +375 17 209 9399

CA – Canada, Milton, Ontario
Tel: +1 905 693 3000

CH – Switzerland
See Germany

CN – China, Shanghai
Tel: +86 21 5031 2525

CN – China, Beijing
Tel: +86 10 6561 0520

CZ – Czech Republic, Klecany
Tel: +420 284 083 111

DE – Germany, Kaarst
Tel: +49 (0)2131 4016 0

DK – Denmark, Ballerup
Tel: +45 43 56 04 00

ES – Spain, Madrid
Tel: +34 902 33 00 01

FI – Finland, Vantaa
Tel: +358 (0)20 753 2500

FR – France,
Contamine-sur-Arve
Tel: +33 (0)4 50 25 80 25

GR – Greece, Athens
Tel: +30 210 933 6450

HK – Hong Kong
Tel: +852 2428 8008

HU – Hungary, Budapest
Tel: +36 1 220 4155

IE – Ireland, Dublin
Tel: +353 (0)1 466 6370

IN – India, Mumbai
Tel: +91 22 6513 7081-85

IT – Italy, Corsico (MI)
Tel: +39 02 45 19 21

JP – Japan, Fujisawa
Tel: +(81) 4 6635 3050

KR – South Korea, Seoul
Tel: +82 2 559 0400

KZ – Kazakhstan, Almaty
Tel: +7 3272 505 800

LV – Latvia, Riga
Tel: +371 74 52601

MX – Mexico, Apodaca
Tel: +52 81 8156 6000

MY – Malaysia, Subang Jaya
Tel: +60 3 5638 1476

NL – The Netherlands,
Oldenzaal
Tel: +31 (0)541 585 000

NO – Norway, Ski
Tel: +47 64 91 10 00

NZ – New Zealand, Mt Wellington
Tel: +64 9 574 1744

PL – Poland, Warsaw
Tel: +48 (0)22 573 24 00

PT – Portugal, Leca
da Palmeira
Tel: +351 22 999 7360

RO – Romania, Bucharest
Tel: +40 21 252 1382

RU – Russia, Moscow
Tel: +7 495 645-2156

SE – Sweden, Spånga
Tel: +46 (0)8 59 79 50 00

SG – Singapore
Tel: +65 6887 6300

SL – Slovenia, Novo Mesto
Tel: +386 7 337 6650

SK – Slovakia
See Czech Republic

TH – Thailand, Bangkok
Tel: +662 717 8140

TR – Turkey, Merter/Istanbul
Tel: +90 212 482 91 06 or 07

TW – Taiwan, Taipei
Tel: +886 2 2298 8987

UA – Ukraine, Kyiv
Tel +380 44 494 2731

UK – United Kingdom,
Warwick
Tel: +44 (0)1926 317 878

US – USA, Cleveland
(Industrial)
Tel: +1 216 896 3000

US – USA, Lincolnshire
(Mobile)
Tel: +1 847 821 1500

US – USA, Miami
(Pan American Division)
Tel: +1 305 470 8800

VE – Venezuela, Caracas
Tel: +58 212 238 5422

ZA – South Africa,
Kempton Park
Tel: +27 (0)11 961 0700

